

E-2000™ FAMILY

E-2000™ SIMPLEX

E-2000™ Simplex standard pigtail P/Ns		
Order Number	Description (Type designation, pigtail length)	Fiber
EMA 1034280	E-2000™ Simplex MM PC standard pigtail, 2.5 m	50/125/900, ML OM3, turquoise
EMA 1034281	E-2000™ Simplex MM PC standard pigtail, 2.5 m	62,5/125/900, TB, white
EMA 1034282	E-2000™ Simplex SM PC standard pigtail, 2.5 m	9/125/900, TB, white
EMA 1034283	E-2000™ Simplex SM PC standard pigtail, 2.5 m	9/125/900, ML, yellow
EMA 1034284	E-2000™ Simplex SM APC standard pigtail, 2.5 m	9/125/900, TB, white
EMA 1034285	E-2000™ Simplex SM APC standard pigtail, 2.5 m	9/125/900, ML, yellow

Notes: For other configurations, please refer to the Order information of the E-2000™ Simplex datasheet.

E-2000™ Simplex standard patchcord P/Ns		
Order Number	Description (Type designation, patch length)	Cable
ENA 1034286	E-2000™ Simplex SM PC standard patchcord, 3 m	9/125/2.1 mm, yellow
ENA 1034287	E-2000™ Simplex SM PC standard patchcord, 3 m	9/125/2.4 mm, yellow
ENA 1034289	E-2000™ Simplex SM PC standard patchcord, 3 m	9/125/3.0 mm, yellow
ENA 1034290	E-2000™ Simplex SM PC standard patchcord, 5 m	9/125/2.1 mm, yellow
ENA 1034291	E-2000™ Simplex SM PC standard patchcord, 5 m	9/125/2.4 mm, yellow
ENA 1034292	E-2000™ Simplex SM PC standard patchcord, 5 m	9/125/3.0 mm, yellow
ENA 1034293	E-2000™ Simplex SM APC standard patchcord, 3 m	9/125/2.1 mm, yellow
ENA 1034306	E-2000™ Simplex SM APC standard patchcord, 3 m	9/125/2.4 mm, yellow
ENA 1034308	E-2000™ Simplex SM APC standard patchcord, 3 m	9/125/3.0 mm, yellow
ENA 1034309	E-2000™ Simplex SM APC standard patchcord, 5 m	9/125/2.1 mm, yellow
ENA 1034311	E-2000™ Simplex SM APC standard patchcord, 5 m	9/125/2.4 mm, yellow
ENA 1034312	E-2000™ Simplex SM APC standard patchcord, 5 m	9/125/3.0 mm, yellow
ENA 1034313	E-2000™ Simplex SM APC 0.1dB standard patchcord, 5 m	9/125/2.1 mm, yellow
ENA 1034314	E-2000™ Simplex SM APC 0.1dB standard patchcord, 5 m	9/125/2.4 mm, yellow
ENA 1034316	E-2000™ Simplex SM APC 0.1dB standard patchcord, 5 m	9/125/3.0 mm, yellow

Notes: For other configurations, please refer to the Order information of the E-2000™ Simplex datasheet.
2.1 and 2.4mm cables are LSOH; 3.0mm is OFNR.

E-2000™ Simplex Mating Adapters Standard P/Ns (New generation)	
Order Number	Description (Type designation, housing/frame colors, fixing type)
EBA 1047168	E-2000™ simplex mating adapter MM, beige / beige, without fixation
EBA 1047169	E-2000™ simplex mating adapter MM, beige / beige, screw fixing clip (M2 x 8 mm steel)
EBA 1047170	E-2000™ simplex mating adapter MM, beige / beige, quick fixing clip (A)
EBA 1047183	E-2000™ simplex mating adapter MM, beige / beige, quick fixing clip (B)
EBA 1047184	E-2000™ simplex mating adapter MM, beige / beige, print fixing clip (6 pins)
EBA 1047185	E-2000™ simplex mating adapter SM PC, blue / blue, without fixation
EBA 1047186	E-2000™ simplex mating adapter SM PC, blue / blue, screw fixing clip (M2 x 8 mm steel)
EBA 1047187	E-2000™ simplex mating adapter SM PC, blue / blue, quick fixing clip (A)
EBA 1047188	E-2000™ simplex mating adapter SM PC, blue / blue, quick fixing clip (B)
EBA 1047189	E-2000™ simplex mating adapter SM PC, blue / blue, print fixing clip (6 pins)
EBA 1045372	E-2000™ simplex mating adapter SM APC, green / green, without fixation
EBA 1047190	E-2000™ simplex mating adapter SM APC, green / green, screw fixing clip (M2 x 8 mm steel)
EBA 1047191	E-2000™ simplex mating adapter SM APC, green / green, quick fixing clip (A)
EBA 1047192	E-2000™ simplex mating adapter SM APC, green / green, quick fixing clip (B)
EBA 1047193	E-2000™ simplex mating adapter SM APC, green / green, print fixing clip (6 pins)
EBA 1047110	E-2000™ simplex mating adapter SM APC 0.1dB, green / green, without fixation
EBA 1047201	E-2000™ simplex mating adapter SM APC 0.1dB, green / green, screw fixing clip (M2 x 8 mm steel)
EBA 1047202	E-2000™ simplex mating adapter SM APC 0.1dB, green / green, quick fixing clip (A)
EBA 1047203	E-2000™ simplex mating adapter SM APC 0.1dB, green / green, quick fixing clip (B)
EBA 1047204	E-2000™ simplex mating adapter SM APC 0.1dB, green / green, print fixing clip (6 pins)

Note: other housing and frame colors upon request

Version 031

E-2000™ SIMPLEX**E-2000™ IP 65 Simplex Mating Adapters Standard P/Ns (New generation)**

Order Number	Description (Type designation, housing/frame colors, fixing type)
EBA 1053632	E-2000™ IP 65 simplex mating adapter MM, beige / beige, without fixation
EBA 1053642	E-2000™ IP 65 simplex mating adapter MM, beige / beige, screw fixing clip (M2 x 8 mm steel)
EBA 1053643	E-2000™ IP 65 simplex mating adapter MM, beige / beige, quick fixing clip (A)
EBA 1053644	E-2000™ IP 65 simplex mating adapter MM, beige / beige, quick fixing clip (B)
EBA 1053645	E-2000™ IP 65 simplex mating adapter SM PC, blue / blue, without fixation
EBA 1053646	E-2000™ IP 65 simplex mating adapter SM PC, blue / blue, screw fixing clip (M2 x 8 mm steel)
EBA 1053647	E-2000™ IP 65 simplex mating adapter SM PC, blue / blue, quick fixing clip (A)
EBA 1053648	E-2000™ IP 65 simplex mating adapter SM PC, blue / blue, quick fixing clip (B)
EBA 1053649	E-2000™ IP 65 simplex mating adapter SM APC, green / green, without fixation
EBA 1053650	E-2000™ IP 65 simplex mating adapter SM APC, green / green, screw fixing clip (M2 x 8 mm steel)
EBA 1053651	E-2000™ IP 65 simplex mating adapter SM APC, green / green, quick fixing clip (A)
EBA 1049884	E-2000™ IP 65 simplex mating adapter SM APC, green / green, quick fixing clip (B)
EBA 1053652	E-2000™ IP 65 simplex mating adapter SM APC 0.1dB, green / green, without fixation
EBA 1053653	E-2000™ IP 65 simplex mating adapter SM APC 0.1dB, green / green, screw fixing clip (M2 x 8 mm steel)
EBA 1053654	E-2000™ IP 65 simplex mating adapter SM APC 0.1dB, green / green, quick fixing clip (A)
EBA 1053655	E-2000™ IP 65 simplex mating adapter SM APC 0.1dB, green / green, quick fixing clip (B)

Notes: every 100 E-2000™ IP 65 mating adapters, a service adapter (GBC 1019034) for O' Ring mounting will be added
Other housing and frame colors upon request

E-2000™ IP 65 ETo Simplex Mating Adapters Standard P/Ns (New generation)

Order Number	Description (Type designation, housing/frame colors, fixing type)
EBA 1063415	E-2000™ IP 65 Eto simplex mating adapter MM, beige / beige, without fixation
EBA 1063416	E-2000™ IP 65 Eto simplex mating adapter MM, beige / beige, screw fixing clip (M2 x 8 mm steel)
EBA 1063417	E-2000™ IP 65 Eto simplex mating adapter MM, beige / beige, quick fixing clip (A)
EBA 1063418	E-2000™ IP 65 Eto simplex mating adapter MM, beige / beige, quick fixing clip (B)
EBA 1063419	E-2000™ IP 65 Eto simplex mating adapter SM PC, blue / blue, without fixation
EBA 1063420	E-2000™ IP 65 Eto simplex mating adapter SM PC, blue / blue, screw fixing clip (M2 x 8 mm steel)
EBA 1063431	E-2000™ IP 65 Eto simplex mating adapter SM PC, blue / blue, quick fixing clip (A)
EBA 1063432	E-2000™ IP 65 Eto simplex mating adapter SM PC, blue / blue, quick fixing clip (B)
EBA 1063433	E-2000™ IP 65 Eto simplex mating adapter SM APC, green / green, without fixation
EBA 1063434	E-2000™ IP 65 Eto simplex mating adapter SM APC, green / green, screw fixing clip (M2 x 8 mm steel)
EBA 1063435	E-2000™ IP 65 Eto simplex mating adapter SM APC, green / green, quick fixing clip (A)
EBA 1063436	E-2000™ IP 65 Eto simplex mating adapter SM APC, green / green, quick fixing clip (B)
EBA 1063437	E-2000™ IP 65 Eto simplex mating adapter SM APC 0.1dB, green / green, without fixation
EBA 1063438	E-2000™ IP 65 Eto simplex mating adapter SM APC 0.1dB, green / green, screw fixing clip (M2 x 8 mm steel)
EBA 1063439	E-2000™ IP 65 Eto simplex mating adapter SM APC 0.1dB, green / green, quick fixing clip (A)
EBA 1063440	E-2000™ IP 65 Eto simplex mating adapter SM APC 0.1dB, green / green, quick fixing clip (B)

Notes: every 100 E-2000™ IP 65 Eto mating adapters, a service adapter (GBC 1019034) for O' Ring mounting will be added
Other housing and frame colors upon request

E-2000™ Simplex Mating Adapter fixing clips P/Ns

Order Number	Description
DA# 1012081	Screw fixing clip
DA# 1012082	Quick fixing clip (Type A)
DA# 1012202	Quick fixing clip (Type B) (2 pieces needed)
DAB 1012091	Print fixing clip (6 pins)
DA# 1032661	45° Screw fixing clip

Note: other fixation types upon request

E-2000™ COMPACT

E-2000™ Compact standard patchcord P/Ns

Order Number	Description (Type designation, patch length)	Cable
ENA 1034317	E-2000™ Compact SM PC standard patchcord, 3 m	9/125/1.6 mm, yellow
ENA 1034318	E-2000™ Compact SM PC standard patchcord, 3 m	9/125/2.8 mm, yellow
ENA 1034319	E-2000™ Compact SM PC standard patchcord, 5 m	9/125/1.6 mm, yellow
ENA 1034320	E-2000™ Compact SM PC standard patchcord, 5 m	9/125/2.8 mm, yellow
ENA 1034321	E-2000™ Compact SM APC standard patchcord, 3 m	9/125/1.6 mm, yellow
ENA 1034323	E-2000™ Compact SM APC standard patchcord, 3 m	9/125/2.8 mm, yellow
ENA 1034324	E-2000™ Compact SM APC standard patchcord, 5 m	9/125/1.6 mm, yellow
ENA 1034325	E-2000™ Compact SM APC standard patchcord, 5 m	9/125/2.8 mm, yellow

Notes: For other configurations, please refer to the Order information of the E-2000™ Compact datasheet.
1.6mm cable is LSOH; 2.8mm is PVC.

E-2000™ Compact Mating Adapters Standard P/Ns (New generation)

Order Number	Description (Type designation, housing/frame colors, fixing type)
EBA 1047205	E-2000™ compact mating adapter MM, beige / beige, without fixation
EBA 1047206	E-2000™ compact mating adapter MM, beige / beige, screw fixing clip (M2 x 8 mm steel)
EBA 1047207	E-2000™ compact mating adapter MM, beige / beige, quick fixing clip
EBA 1047208	E-2000™ compact mating adapter MM, beige / beige, print fixing clip (snap closure)
EBA 1047209	E-2000™ compact mating adapter MM, beige / beige, print fixing clip (6 pins)
EBA 1047210	E-2000™ compact mating adapter SM PC, blue / blue, without fixation
EBA 1047211	E-2000™ compact mating adapter SM PC, blue / blue, screw fixing clip (M2 x 8 mm steel)
EBA 1047212	E-2000™ compact mating adapter SM PC, blue / blue, quick fixing clip
EBA 1047213	E-2000™ compact mating adapter SM PC, blue / blue, print fixing clip (snap closure)
EBA 1047214	E-2000™ compact mating adapter SM PC, blue / blue, print fixing clip (6 pins)
EBA 1045373	E-2000™ compact mating adapter SM APC, green / green, without fixation
EBA 1047215	E-2000™ compact mating adapter SM APC, green / green, screw fixing clip (M2 x 8 mm steel)
EBA 1047216	E-2000™ compact mating adapter SM APC, green / green, quick fixing clip
EBA 1047217	E-2000™ compact mating adapter SM APC, green / green, print fixing clip (snap closure)
EBA 1047218	E-2000™ compact mating adapter SM APC, green / green, print fixing clip (6 pins)
EBA 1047219	E-2000™ compact mating adapter SM APC 0.1dB, green / green, without fixation
EBA 1047220	E-2000™ compact mating adapter SM APC 0.1dB, green / green, screw fixing clip (M2 x 8 mm steel)
EBA 1047221	E-2000™ compact mating adapter SM APC 0.1dB, green / green, quick fixing clip
EBA 1047222	E-2000™ compact mating adapter SM APC 0.1dB, green / green, print fixing clip (snap closure)
EBA 1047223	E-2000™ compact mating adapter SM APC 0.1dB, green / green, print fixing clip (6 pins)

Note: other housing and frame colors upon request

E-2000™ IP 65 Compact Mating Adapters Standard P/Ns (New generation)

Order Number	Description (Type designation, housing/frame colors, fixing type)
EBA 1053656	E-2000™ IP 65 compact mating adapter MM, beige / beige, without fixation
EBA 1053657	E-2000™ IP 65 compact mating adapter MM, beige / beige, screw fixing clip (M2 x 8 mm steel)
EBA 1053658	E-2000™ IP 65 compact mating adapter MM, beige / beige, quick fixing clip
EBA 1053659	E-2000™ IP 65 compact mating adapter SM PC, blue / blue, without fixation
EBA 1053660	E-2000™ IP 65 compact mating adapter SM PC, blue / blue, screw fixing clip (M2 x 8 mm steel)
EBA 1053661	E-2000™ IP 65 compact mating adapter SM PC, blue / blue, quick fixing clip
EBA 1053662	E-2000™ IP 65 compact mating adapter SM APC, green / green, without fixation
EBA 1049886	E-2000™ IP 65 compact mating adapter SM APC, green / green, screw fixing clip (M2 x 8 mm steel)
EBA 1053663	E-2000™ IP 65 compact mating adapter SM APC, green / green, quick fixing clip
EBA 1053664	E-2000™ IP 65 compact mating adapter SM APC 0.1dB, green / green, without fixation
EBA 1053665	E-2000™ IP 65 compact mating adapter SM APC 0.1dB, green / green, screw fixing clip (M2 x 8 mm steel)
EBA 1053666	E-2000™ IP 65 compact mating adapter SM APC 0.1dB, green / green, quick fixing clip

Notes: every 100 E-2000™ IP 65 mating adapters, a service adapter (GBC 1019034) for O' Ring mounting will be added
Other housing and frame colors upon request

Version 031

E-2000™ COMPACT**E-2000™ IP 65 EtO Compact Mating Adapters Standard P/Ns (New generation)**

Order Number	Description (Type designation, housing/frame colors, fixing type)
EBA 1063441	E-2000™ IP 65 EtO compact mating adapter MM, beige / beige, without fixation
EBA 1063442	E-2000™ IP 65 EtO compact mating adapter MM, beige / beige, screw fixing clip (M2 x 8 mm steel)
EBA 1063443	E-2000™ IP 65 EtO compact mating adapter MM, beige / beige, quick fixing clip
EBA 1063444	E-2000™ IP 65 EtO compact mating adapter SM PC, blue / blue, without fixation
EBA 1063445	E-2000™ IP 65 EtO compact mating adapter SM PC, blue / blue, screw fixing clip (M2 x 8 mm steel)
EBA 1063446	E-2000™ IP 65 EtO compact mating adapter SM PC, blue / blue, quick fixing clip
EBA 1063450	E-2000™ IP 65 EtO compact mating adapter SM APC, green / green, without fixation
EBA 1063451	E-2000™ IP 65 EtO compact mating adapter SM APC, green / green, screw fixing clip (M2 x 8 mm steel)
EBA 1063452	E-2000™ IP 65 EtO compact mating adapter SM APC, green / green, quick fixing clip
EBA 1063454	E-2000™ IP 65 EtO compact mating adapter SM APC 0.1dB, green / green, without fixation
EBA 1063457	E-2000™ IP 65 EtO compact mating adapter SM APC 0.1dB, green / green, screw fixing clip (M2 x 8 mm steel)
EBA 1063462	E-2000™ IP 65 EtO compact mating adapter SM APC 0.1dB, green / green, quick fixing clip

Notes: every 100 E-2000™ IP 65 EtO mating adapters , a service adapter (GBC 1019034) for O' Ring mounting will be added

Other housing and frame colors upon request

E-2000™ Compact Mating Adapter fixing clips P/Ns

Order Number	Description
DA# 1012078	Screw fixing clip
DA# 1022803	Quick fixing clip (2 pieces needed)
DA# 1012080	Print fixing clip (snap closure)
DAB 1012090	Print fixing clip (6 pins)
DA# 1012208	45° Screw fixing clip

Note: other fixation types upon request

Version 062

E-2000™ DUPLEX**E-2000™ Duplex standard patchcord P/Ns**

Order Number	Description (Type designation, patch length)	Cable
ENA 1034326	E-2000™ Duplex SM PC standard patchcord, 3 m	9/125/1.6 mm, yellow
ENA 1034327	E-2000™ Duplex SM PC standard patchcord, 3 m	9/125/2.8 mm, yellow
ENA 1034328	E-2000™ Duplex SM PC standard patchcord, 5 m	9/125/1.6 mm, yellow
ENA 1034329	E-2000™ Duplex SM PC standard patchcord, 5 m	9/125/2.8 mm, yellow
ENA 1034330	E-2000™ Duplex SM APC standard patchcord, 3 m	9/125/1.6 mm, yellow
ENA 1034331	E-2000™ Duplex SM APC standard patchcord, 3 m	9/125/2.8 mm, yellow
ENA 1034332	E-2000™ Duplex SM APC standard patchcord, 5 m	9/125/1.6 mm, yellow
ENA 1034333	E-2000™ Duplex SM APC standard patchcord, 5 m	9/125/2.8 mm, yellow

Notes: For other configurations, please refer to the Order information of the E-2000™ Duplex datasheet.
1.6mm cable is LSOH; 2.8mm is PVC.

E-2000™ Duplex Mating Adapters Standard P/Ns

Order Number	Description (Type designation, housing/frame colors)
EBA 1027108	E-2000™ Duplex mating adapter MM, beige / beige (M2 x 8 mm steel)
EBA 1013665	E-2000™ Duplex mating adapter SM PC, blue / blue (M2 x 8 mm steel)
EBA 1013648	E-2000™ Duplex mating adapter SM APC, green / green (M2 x 8 mm steel)

Note: other housing and frame colors upon request

Version 036

E-2000™ BACKPLANE

E-2000™ PCB Adapters Standard P/Ns	
Order Number	Description (Type designation, housing colors)
EBA 1019050	E-2000™ PCB adapter 2 x, black (M3 x 5 mm inox)
EBA 1019041	E-2000™ PCB adapter 6 x, black (M3 x 5 mm inox)

E-2000™ Backplane Adapters Standard P/Ns	
Order Number	Description (Type designation, housing colors)
EBA 1027109	E-2000™ Backplane adapter 2 x MM, beige (M2 x 8 mm inox)
EBA 1013611	E-2000™ Backplane adapter 2 x SM PC, blue (M2 x 8 mm inox)
EBA 1013612	E-2000™ Backplane adapter 2 x SM APC, green (M2 x 8 mm inox)
EBA 1013718	E-2000™ Backplane adapter 2 x SM APC 0.1 dB, green (M2 x 8 mm inox)
EBA 1027110	E-2000™ Backplane adapter 6 x MM, beige (M2 x 8 mm inox)
EBA 1013602	E-2000™ Backplane adapter 6 x SM PC, blue (M2 x 8 mm inox)
EBA 1013603	E-2000™ Backplane adapter 6 x SM APC, green (M2 x 8 mm inox)
EBA 1013683	E-2000™ Backplane adapter 6 x SM APC 0.1 dB, green (M2 x 8 mm inox)

Note: other housing colors upon request

Version 015

E-2000™ Interlock

E-2000™ Interlock

E-2000™ Interlock Mating Adapters Standard P/Ns (New generation)

Order Number	Description (Type designation, housing/frame colors, fixing type)
EBA 1047242	E-2000™ Interlock simplex mating adapter, red / red, without fixation
EBA 1047247	E-2000™ Interlock simplex mating adapter, red / red, print fixing clip (6 pins)

Note: other housing and frame colors upon request

E-2000™ Simplex Mating Adapter fixing clips P/Ns

Order Number	Description
DAF 1012091	Print fixing clip (6 pins)

Note: other fixation types upon request

Version 0115

POWER SOLUTION FAMILY

E-2000™ PS SIMPLEX

E-2000™ PS Simplex Mating Adapters Standard P/Ns (New generation)

Order Number	Description (Type designation, housing/frame colors, fixing type)
EBA 1047242	E-2000™ PS simplex mating adapter, red / red, without fixation
EBA 1047243	E-2000™ PS simplex mating adapter, red / red, screw fixing clip (M2 x 8 mm steel)
EBA 1047244	E-2000™ PS simplex mating adapter, red / red, quick fixing clip (A)
EBA 1047245	E-2000™ PS simplex mating adapter, red / red, quick fixing clip (B)
EBA 1047247	E-2000™ PS simplex mating adapter, red / red, print fixing clip (6 pins)

Note: other housing and frame colors upon request

E-2000™ PS IP65 Simplex Mating Adapters Standard P/Ns (New generation)

Order Number	Description (Type designation, housing/frame colors, fixing type)
EBA 1063476	E-2000™ PS IP65 simplex mating adapter, red / red, without fixation
EBA 1063477	E-2000™ PS IP65 simplex mating adapter, red / red, screw fixing clip (M2 x 8 mm steel)
EBA 1063478	E-2000™ PS IP65 simplex mating adapter, red / red, quick fixing clip (A)
EBA 1063479	E-2000™ PS IP65 simplex mating adapter, red / red, quick fixing clip (B)

Note: every 100 E-2000™ PS IP65 mating adapters, a service adapter (GBC 1019034) for O' Ring mounting will be added

Note: other housing and frame colors upon request

E-2000™ PS IP65 EtO Simplex Mating Adapters Standard P/Ns (New generation)

Order Number	Description (Type designation, housing/frame colors, fixing type)
EBA 1063463	E-2000™ PS IP65 EtO simplex mating adapter, red / red, without fixation
EBA 1063464	E-2000™ PS IP65 EtO simplex mating adapter, red / red, screw fixing clip (M2 x 8 mm steel)
EBA 1063465	E-2000™ PS IP65 EtO simplex mating adapter, red / red, quick fixing clip (A)
EBA 1063467	E-2000™ PS IP65 EtO simplex mating adapter, red / red, quick fixing clip (B)

Note: every 100 E-2000™ PS IP65 EtO mating adapters, a service adapter (GBC 1019034) for O' Ring mounting will be added

Note: other housing and frame colors upon request

E-2000™ Simplex Mating Adapter fixing clips P/Ns

Order Number	Description
DA# 1012081	Screw fixing clip
DA# 1012082	Quick fixing clip (Type A)
DA# 1012202	Quick fixing clip (Type B)
DA# 1012091	Print fixing clip (6 pins)
DA# 1032661	45° Screw fixing clip

Note: other fixation types upon request

E-2000™ PS BACKPLANE

E-2000™ PCB Adapter Standard P/N

Order Number	Description (Type designation, color)
EBA 1019041	E-2000™ PCB adapter 6 x, black (M3 x 5 mm inox)

E-2000™ PS Backplane Adapter Standard P/N

Order Number	Description (Type designation, color)
EBA 1037451	E-2000™ PS Backplane adapter 6 x, red (M2 x 8 mm inox)

Version 024

F-3000™ PS SIMPLEX**F-3000™ PS Simplex Mating Adapters Standard P/Ns**

Order Number	Description (Type designation, color)
EBB 1016465	F-3000™ PS simplex mating adapter, red, without fixation
EBB 1016471	F-3000™ PS simplex mating adapter, red, screw fixing clip (M2 x 4 mm steel)
EBB 1030570	F-3000™ PS simplex mating adapter, red, quick fixing clip

Note: other fixation types upon request

F-3000™ Simplex Mating Adapter fixing clips P/Ns

Order Number	Description (Type designation, color)
DAF 1012092	Screw fixing clip
DAF 1029136	Quick fixing clip (2 pieces needed)

Note: other fixation types upon request

DMI PS**DMI PS Mating Adapters P/Ns**

Order Number	Description (Type designation, color)
EBN 1045682	DMI PS mating adapter PC & APC4°, red
DAB 1009209	DMI mating adapter clip
EZ 1063581	DMI mounting set for clip (Screw M2 x 5mm A4 INOX ISO7380; Nut DIN934 INOX)
GBC 1032053	DMI mounting tool

DMI Mounting Instructions**Fixing DMI assembling onto the clip:**

- 1) Position one lateral site of DMI assembly into the clip
(be sure that the V-Groove of DMI connector is correct (see detail))
- 2) Position the DMI on the other side of DMI assembly and press down on DMI clip

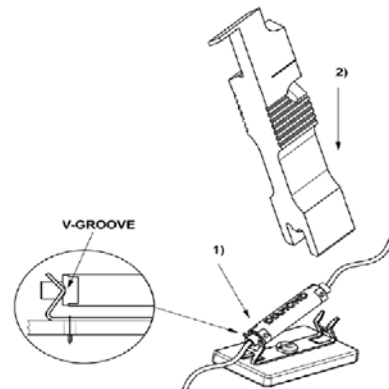
**Releasing DMI assembling from the clip:**

- 1) Position DMI tool between DMI assembly and clip
- 2) Push the DMI tool down to release the DMI assembly

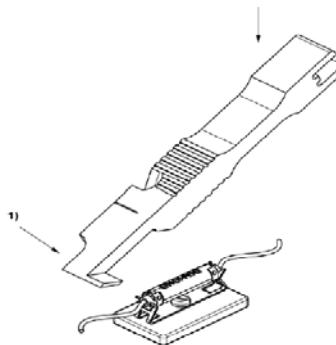
**Uncoupling of DMI connector from mating adapter:**

- 1) Position DMI assembly on DMI tool.
(Be sure that the blade of DMI tool is positioned between DMI adapter and connector)
- 2) Pull the DMI assembly to uncouple connector from adapter

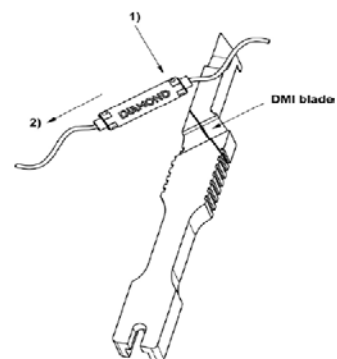

F-3000™ FAMILY

F-3000™ SIMPLEX

F-3000™ Simplex standard pigtail P/Ns

Order Number	Description (Type designation, pigtail length)	Fiber
EME 1046533	F-3000™ Simplex MM PC standard pigtail, 2.5 m	50/125/900, ML OM3, turquoise
EME 1046534	F-3000™ Simplex MM PC standard pigtail, 2.5 m	62,5/125/900, TB, white
EME 1046535	F-3000™ Simplex SM PC standard pigtail, 2.5 m	9/125/900, TB, white
EME 1046536	F-3000™ Simplex SM PC standard pigtail, 2.5 m	9/125/900, ML, yellow
EME 1046537	F-3000™ Simplex SM APC standard pigtail, 2.5 m	9/125/900, TB, white
EME 1046538	F-3000™ Simplex SM APC standard pigtail, 2.5 m	9/125/900, ML, yellow

Notes: For other configurations, please refer to the Order information of the F-3000™ Simplex datasheet.

F-3000™ Simplex standard patchcord P/Ns

Order Number	Description (Type designation, patch length)	Cable
ENB 1046539	F-3000™ Simplex SM PC standard patchcord, 3 m	9/125/1.6 mm, yellow
ENB 1046540	F-3000™ Simplex SM PC standard patchcord, 3 m	9/125/2.4 mm, yellow
ENB 1046551	F-3000™ Simplex SM PC standard patchcord, 3 m	9/125/3.0 mm, yellow
ENB 1046552	F-3000™ Simplex SM PC standard patchcord, 5 m	9/125/1.6 mm, yellow
ENB 1046553	F-3000™ Simplex SM PC standard patchcord, 5 m	9/125/2.4 mm, yellow
ENB 1046554	F-3000™ Simplex SM PC standard patchcord, 5 m	9/125/3.0 mm, yellow
ENB 1046555	F-3000™ Simplex SM APC standard patchcord, 3 m	9/125/1.6 mm, yellow
ENB 1046556	F-3000™ Simplex SM APC standard patchcord, 3 m	9/125/2.4 mm, yellow
ENB 1046557	F-3000™ Simplex SM APC standard patchcord, 3 m	9/125/3.0 mm, yellow
ENB 1046558	F-3000™ Simplex SM APC standard patchcord, 5 m	9/125/1.6 mm, yellow
ENB 1046559	F-3000™ Simplex SM APC standard patchcord, 5 m	9/125/2.4 mm, yellow
ENB 1046560	F-3000™ Simplex SM APC standard patchcord, 5 m	9/125/3.0 mm, yellow

Notes: For other configurations, please refer to the Order information of the F-3000™ Simplex datasheet.
1.6 and 2.4mm cables are LSOH; 3.0mm is OFNR.

F-3000™ Simplex Mating Adapters Standard P/Ns

Order Number	Description (Type designation, housing color, fixing type)
EBB 1026971	F-3000™ simplex mating adapter MM, beige, without fixation
EBB 1026972	F-3000™ simplex mating adapter MM, beige, screw fixing clip (M2 x 4 mm steel)
EBB 1029151	F-3000™ simplex mating adapter MM, beige, quick fixing clip
EBB 1016452	F-3000™ simplex mating adapter SM PC, blue, without fixation
EBB 1016462	F-3000™ simplex mating adapter SM PC, blue, screw fixing clip (M2 x 4 mm steel)
EBB 1029139	F-3000™ simplex mating adapter SM PC, blue, quick fixing clip
EBB 1016448	F-3000™ simplex mating adapter SM APC, green, without fixation
EBB 1016455	F-3000™ simplex mating adapter SM APC, green, screw fixing clip (M2 x 4 mm steel)
EBB 1029140	F-3000™ simplex mating adapter SM APC, green, quick fixing clip

Note: other housing colors upon request

F-3000™ Simplex Mating Adapter fixing clips P/Ns

Order Number	Description
DAF 1012092	Screw fixing clip
DAF 1029136	Quick fixing clip (2 pieces needed)

Note: other fixation types upon request

F-3000™ DUPLEX**F-3000™ Duplex standard patchcord P/Ne**

Order Number	Description (Type designation, patch length)	Cable
ENB 1046561	F-3000™ Duplex SM PC standard patchcord, 3 m	9/125/1.6 mm, yellow
ENB 1046562	F-3000™ Duplex SM PC standard patchcord, 3 m	9/125/2.1 mm, yellow
ENB 1046563	F-3000™ Duplex SM PC standard patchcord, 5 m	9/125/1.6 mm, yellow
ENB 1046564	F-3000™ Duplex SM PC standard patchcord, 5 m	9/125/2.1 mm, yellow
ENB 1046565	F-3000™ Duplex SM APC standard patchcord, 3 m	9/125/1.6 mm, yellow
ENB 1046566	F-3000™ Duplex SM APC standard patchcord, 3 m	9/125/2.1 mm, yellow
ENB 1046568	F-3000™ Duplex SM APC standard patchcord, 5 m	9/125/1.6 mm, yellow
ENB 1046569	F-3000™ Duplex SM APC standard patchcord, 5 m	9/125/2.1 mm, yellow

Notes: For other configurations, please refer to the Order information of the F-3000™ Duplex datasheet.
Assembled with LSOH cable type.

F-3000™ Duplex Mating Adapters Standard P/Ne

Order Number	Description (Type designation, housing color, fixing type)
EBB 1026974	F-3000™ Duplex mating adapter MM, beige, without fixation
EBB 1026975	F-3000™ Duplex mating adapter MM, beige, screw fixing clip (M2 x 4 mm steel)
EBB 1026976	F-3000™ Duplex mating adapter MM, beige, quick fixing clip
EBB 1026977	F-3000™ Duplex mating adapter MM, beige, 45° screw fixing clip (M2 x 4 mm steel)
EBB 1067897	F-3000™ Junior mating adapter MM, beige, (quick fixing clip Type B, E-2000™ simplex)
EBB 1067900	F-3000™ Junior mating adapter MM, beige, (screw fixing clip Type E-2000™ simplex)
EBB 1016453	F-3000™ Duplex mating adapter SM PC, blue, without fixation
EBB 1016458	F-3000™ Duplex mating adapter SM PC, blue, screw fixing clip (M2 x 4 mm steel)
EBB 1023532	F-3000™ Duplex mating adapter SM PC, blue, quick fixing clip
EBB 1026978	F-3000™ Duplex mating adapter SM PC, blue, 45° screw fixing clip (M2 x 4 mm steel)
EBB 1067898	F-3000™ Junior mating adapter SM PC, blue, (quick fixing clip Type B, E-2000™ simplex)
EBB 1067901	F-3000™ Junior mating adapter SM PC, blue, (screw fixing clip Type E-2000™ simplex)
EBB 1016454	F-3000™ Duplex mating adapter SM APC, green, without fixation
EBB 1016456	F-3000™ Duplex mating adapter SM APC, green, screw fixing clip (M2 x 4 mm steel)
EBB 1025302	F-3000™ Duplex mating adapter SM APC, green, quick fixing clip
EBB 1026979	F-3000™ Duplex mating adapter SM APC, green, 45° screw fixing clip (M2 x 4 mm steel)
EBB 1067899	F-3000™ Junior mating adapter SM APC, green, (quick fixing clip Type B, E-2000™ simplex)
EBB 1067903	F-3000™ Junior mating adapter SM APC, green, (screw fixing clip Type E-2000™ simplex)

Note: other housing colors upon request

F-3000™ Duplex Mating Adapter fixing clips P/Ne

Order Number	Description
DAF 1012099	Screw fixing clip (F-3000™)
DAF 1023458	Quick fixing clip F-3000™ (2 pieces needed)
DAF 1012207	45° screw fixing clip, F-3000™
DAF 1012202	Quick fixing clip (Type B, E-2000™ simplex), 2 pieces needed
DAF 1012081	Screw fixing clip (E-2000™ simplex)

Note: other fixation types upon request

F-3000™ BACKPLANE

F-3000™ PCB Adapters Standard P/No	
Order Number	Description (Type designation, housing colors)

EBB 1011164	F-3000™ PCB adapter 2 x, black (M2 x 5 mm inox)
EBB 1016451	F-3000™ PCB adapter 4 x, black (M2 x 5 mm inox)

F-3000™ Backplane Adapters Standard P/No	
Order Number	Description (Type designation, housing colors)

EBB 1027082	F-3000™ Backplane adapter 2 x MM, beige (M2 x 6 mm inox)
EBB 1023894	F-3000™ Backplane adapter 2 x SM PC, blue (M2 x 6 mm inox)
EBB 1023895	F-3000™ Backplane adapter 2 x SM APC, green (M2 x 6 mm inox)
EBB 1027083	F-3000™ Backplane adapter 4 x MM, beige (M2 x 6 mm inox)
EBB 1023892	F-3000™ Backplane adapter 4 x SM PC, blue (M2 x 6 mm inox)
EBB 1023893	F-3000™ Backplane adapter 4 x SM APC, green (M2 x 6 mm inox)

Note: other housing colors upon request

Version 015

F-3000™ POWER SOLUTION**F-3000™ PS SIMPLEX****F-3000™ PS Simplex Mating Adapters Standard P/Ns**

Order Number	Description (Type designation, housing color, fixing type)
EBB 1016465	F-3000™ PS simplex mating adapter, red, without fixation
EBB 1016471	F-3000™ PS simplex mating adapter, red, screw fixing clip (M2 x 4 mm steel)
EBB 1030570	F-3000™ PS simplex mating adapter, red, quick fixing clip

Note: other housing colors upon request

F-3000™ Simplex Mating Adapter fixing clips P/Ns

Order Number	Description
DAF 1012092	Screw fixing clip
DAF 1029136	Quick fixing clip (2 pieces needed)

Note: other fixation types upon request

Version 078

F-3000™ r & rs**F-3000™ r / F-3000™ rs Field termination Kit**

Order Number	Description
GBB 1048660	F-3000™r & rs Semi-connector Field termination kit
GBA 1047343	Mounting tool
BCC 1043078	Crimping pliers

Note: For additional housings, spare parts, cable boots etc., please contact your local Diamond representative.

F-3000™ r Connector Sets Standard P/Ns

Order Number	Description (Type designation, housing/straight boot colors, fiber type)	Cable
EAB 1049680	F-3000™r Connector set simplex MM PC, black / black, 50 µm	1.8 mm
EAB 1049691	F-3000™r Connector set simplex MM PC, black / beige, 62.5 µm	1.8 mm
EAB 1049692	F-3000™r Connector set simplex SM PC, black / blue, 9 µm	1.8 mm

F-3000™ rs Connector Sets Standard P/Ns

Order Number	Description (Type designation, housing/straight boot colors, fiber type)	Cable
EAB 1048658	F-3000™rs Connector set simplex MM PC, black / black, 50 µm	1.8 mm
EAB 1048659	F-3000™rs Connector set simplex MM PC, black / beige, 62.5 µm	1.8 mm
EAB 1048656	F-3000™rs Connector set simplex SM PC, black / blue, 9 µm	1.8 mm

Note: other housing and boot colors, as well as fiber/cable types upon request.

For adapter and fixing clips ordering information, please refer to the respective part-specific F-3000™ Simplex Mating Adapter P/N lists.

Version 088

MU FAMILY

MU SIMPLEX

MU Simplex standard pigtail P/Ns

Order Number	Description (Type designation, pigtail length)	Fiber
EMG 1029837	MU Simplex MM PC standard pigtail, 2.5 m	50/125/900, ML OM3, turquoise
EMG 1029838	MU Simplex MM PC standard pigtail, 2.5 m	62,5/125/900, TB, white
EMG 1029813	MU Simplex SM PC standard pigtail, 2.5 m	9/125/900, TB, white
EMG 1029816	MU Simplex SM PC standard pigtail, 2.5 m	9/125/900, ML, yellow
EMG 1029815	MU Simplex SM APC standard pigtail, 2.5 m	9/125/900, TB, white
EMG 1029817	MU Simplex SM APC standard pigtail, 2.5 m	9/125/900, ML, yellow

Notes: For other configurations, please refer to the Order information of the MU datasheet.

MU Simplex standard patchcord P/Ns

Order Number	Description (Type designation, patch length)	Cable
ENG 1025060	MU Simplex SM PC standard patchcord, 3 m	9/125/1.6 mm, yellow
ENG 1027523	MU Simplex SM PC standard patchcord, 3 m	9/125/2.1 mm, yellow
ENG 1027532	MU Simplex SM PC standard patchcord, 5 m	9/125/1.6 mm, yellow
ENG 1027524	MU Simplex SM PC standard patchcord, 5 m	9/125/2.1 mm, yellow
ENG 1025057	MU Simplex SM APC standard patchcord, 3 m	9/125/1.6 mm, yellow
ENG 1027521	MU Simplex SM APC standard patchcord, 3 m	9/125/2.1 mm, yellow
ENG 1027533	MU Simplex SM APC standard patchcord, 5 m	9/125/1.6 mm, yellow
ENG 1027522	MU Simplex SM APC standard patchcord, 5 m	9/125/2.1 mm, yellow

Notes: For other configurations, please refer to the Order information of the MU datasheet.
Assembled with LSOH cable type.

MU Simplex Mating Adapters Standard P/Ns

Order Number	Description (Type designation, housing colors, fixing types)
EBG 1026980	MU simplex mating adapter MM, beige, screw fixing clip
EBG 1026992	MU simplex mating adapter MM, beige, quick fixing clip
EBG 1016538	MU simplex mating adapter SM PC, blue, screw fixing clip
EBG 1016540	MU simplex mating adapter SM PC, blue, quick fixing clip
EBG 1016539	MU simplex mating adapter SM APC, green, screw fixing clip
EBG 1016543	MU simplex mating adapter SM APC, green, quick fixing clip

MU DUPLEX

MU Duplex standard patchcord P/Ns

Order Number	Description (Type designation, patch length)	Cable
ENG 1025059	MU Duplex SM PC standard patchcord, 3 m	9/125/1.6 mm, yellow
ENG 1027535	MU Duplex SM PC standard patchcord, 5 m	9/125/1.6 mm, yellow
ENG 1025058	MU Duplex SM APC standard patchcord, 3 m	9/125/1.6 mm, yellow
ENG 1027534	MU Duplex SM APC standard patchcord, 5 m	9/125/1.6 mm, yellow

Notes: For other configurations, please refer to the Order information of the MU datasheet.
Assembled with LSOH cable type.

MU Duplex Mating Adapters Standard P/Ns	
Order Number	Description (Type designation, housing colors, fixing types)
EBG 1026993	MU Duplex mating adapter MM, beige, screw fixing clip
EBG 1026994	MU Duplex mating adapter MM, beige, quick fixing clip
EBG 1016541	MU Duplex mating adapter SM PC, blue, screw fixing clip
EBG 1016544	MU Duplex mating adapter SM PC, blue, quick fixing clip
EBG 1016542	MU Duplex mating adapter SM APC, green, screw fixing clip
EBG 1016545	MU Duplex mating adapter SM APC, green, quick fixing clip

Version 015

SC FAMILY

SC SIMPLEX

SC Simplex standard pigtail P/Ns

Order Number	Description (Type designation, pigtail length)	Fiber
EMC 1034470	SC Simplex MM PC standard pigtail, 2.5 m	50/125/900, TB, white
EMC 1034334	SC Simplex MM PC standard pigtail, 2.5 m	62,5/125/900, TB, white
EMC 1034335	SC Simplex SM PC standard pigtail, 2.5 m	9/125/900, TB, white
EMC 1034336	SC Simplex SM PC standard pigtail, 2.5 m	9/125/900, ML, yellow
EMC 1034337	SC Simplex SM APC standard pigtail, 2.5 m	9/125/900, TB, white
EMC 1034338	SC Simplex SM APC standard pigtail, 2.5 m	9/125/900, ML, yellow

Notes: For other configurations, please refer to the Order information of the SC Simplex datasheet.

SC Simplex standard patchcord P/Ns

Order Number	Description (Type designation, patch length)	Cable
ENC 1034339	SC Simplex SM PC standard patchcord, 3 m	9/125/1.6 mm, yellow
ENC 1034340	SC Simplex SM PC standard patchcord, 3 m	9/125/2.4 mm, yellow
ENC 1034341	SC Simplex SM PC standard patchcord, 3 m	9/125/3.0 mm, yellow
ENC 1034342	SC Simplex SM PC standard patchcord, 5 m	9/125/1.6 mm, yellow
ENC 1034343	SC Simplex SM PC standard patchcord, 5 m	9/125/2.4 mm, yellow
ENC 1034344	SC Simplex SM PC standard patchcord, 5 m	9/125/3.0 mm, yellow
ENC 1034345	SC Simplex SM APC standard patchcord, 3 m	9/125/1.6 mm, yellow
ENC 1034346	SC Simplex SM APC standard patchcord, 3 m	9/125/2.4 mm, yellow
ENC 1034347	SC Simplex SM APC standard patchcord, 3 m	9/125/3.0 mm, yellow
ENC 1034348	SC Simplex SM APC standard patchcord, 5 m	9/125/1.6 mm, yellow
ENC 1034349	SC Simplex SM APC standard patchcord, 5 m	9/125/2.4 mm, yellow
ENC 1034350	SC Simplex SM APC standard patchcord, 5 m	9/125/3.0 mm, yellow

Notes: For other configurations, please refer to the Order information of the SC Simplex datasheet.
1.6 and 2.4mm cables are LSOH; 3.0mm is OFNR.

SC Simplex Mating Adapters Standard P/Ns

Order Number	Description (Type designation, housing colors, fixing type)
Screw & clip fixing type	
EBC 1027303	SC simplex mating adapter MM, beige, screw & clip fixing type (M2 x 8 mm steel)
EBC 1015025	SC simplex mating adapter SM PC, blue, screw & clip fixing type (M2 x 8 mm steel)
EBC 1015026	SC simplex mating adapter SM APC, green, screw & clip fixing type (M2 x 8 mm steel)
Small quick fixing type	
EBC 1027301	SC simplex mating adapter MM (small), beige, quick fixing clip
EBC 1015041	SC simplex mating adapter SM PC (small), blue, quick fixing clip
EBC 1015042	SC simplex mating adapter SM APC (small), green, quick fixing clip
Screw-nut fixation	
EBC 1027302	SC simplex mating adapter MM, beige, screw-nut fixation (M2 x 8 mm steel)
EBC 1015043	SC simplex mating adapter SM PC, blue, screw-nut fixation (M2 x 8 mm steel)
EBC 1015044	SC simplex mating adapter SM APC, green, screw-nut fixation (M2 x 8 mm steel)

Version 036

SC DUPLEX

SC Duplex Mating Adapters Standard P/Ns	
Order Number	Description (Type designation, housing colors)
EBC 1027260	SC Duplex mating adapter MM, beige (M2 x 8 mm steel)
EBC 1015029	SC Duplex mating adapter SM PC, blue (M2 x 8 mm steel)
EBC 1015028	SC Duplex mating adapter SM APC, green (M2 x 8 mm steel)

Version 1014

LSA (DIN) FAMILY

LSA (DIN) standard pigtail P/Ne

Order Number	Description (Type designation, pigtail length)	Fiber
EMH 1034359	LSA (DIN) MM PC standard pigtail, 2.5 m	50/125/900, ML OM3, turquoise
EMH 1034360	LSA (DIN) MM PC standard pigtail, 2.5 m	62,5/125/900, TB, white
EMH 1034361	LSA (DIN) SM PC standard pigtail, 2.5 m	9/125/900, TB, white
EMH 1034362	LSA (DIN) SM PC standard pigtail, 2.5 m	9/125/900, ML, yellow
EMH 1034363	LSA (DIN) SM APC standard pigtail, 2.5 m	9/125/900, TB, white
EMH 1034364	LSA (DIN) SM APC standard pigtail, 2.5 m	9/125/900, ML, yellow

Notes: For other configurations, please refer to the Order information of the LSA (DIN) datasheet.

LSA (DIN) standard patchcord P/Ne

Order Number	Description (Type designation, patch length)	Cable
ENH 1034365	LSA (DIN) SM PC standard patchcord, 3 m	9/125/2.4 mm, yellow
ENH 1034366	LSA (DIN) SM PC standard patchcord, 3 m	9/125/3.0 mm, yellow
ENH 1034367	LSA (DIN) SM PC standard patchcord, 5 m	9/125/2.4 mm, yellow
ENH 1034368	LSA (DIN) SM PC standard patchcord, 5 m	9/125/3.0 mm, yellow
ENH 1034369	LSA (DIN) SM APC standard patchcord, 3 m	9/125/2.4 mm, yellow
ENH 1034370	LSA (DIN) SM APC standard patchcord, 3 m	9/125/3.0 mm, yellow
ENH 1034371	LSA (DIN) SM APC standard patchcord, 5 m	9/125/2.4 mm, yellow
ENH 1034372	LSA (DIN) SM APC standard patchcord, 5 m	9/125/3.0 mm, yellow

Notes: For other configurations, please refer to the Order information of the LSA (DIN) datasheet.
2.4mm cable is LSOH; 3.0mm is OFNR.

LSA (DIN) Mating Adapter Standard P/Ne

Order Number	Description (Type designation)
EBH 1014328	LSA (DIN) mating adapter

Version 036

AVIO / AVIM FAMILY

AVIO

AVIO Mating Adapter Standard P/Ns	
Order Number	Description (Type designation)
EBH 1026819	AVIO mating adapter

AVIM

AVIM Mating Adapter Standard P/Ns	
Order Number	Description (Type designation)
EBH 1028003	AVIM mating adapter hexagonal flange
EBH 1073322	AVIM Mating adapter square flange no O-ring
EBH 1073699	AVIM Mating adapter square flange with O-ring

AVIM Interconnection tools P/Ns	
Order Number	Description (Type designation)
GBA 1027834	6 mm Torque wrench calibrated to 0.3 Nm (For torquing AVIM Connector)
GBA 1027835	8 mm Torque wrench calibrated to 1.5 Nm (For torquing AVIM Bulkhead nut)
GBA 1027836	11 mm Torque wrench calibrated to 1.0 Nm (For torquing AVIM Coupling nut)
GBA 1030366	Holding tool for AVIM adapter while mounting

AVIM Mating Adapter Space Qualified P/Ns	
Order Number	Description (Type designation)
EBH 1027834	AVIM mating adapter hexagonal flange SQ
EBH 1027835	AVIM mating adapter square flange SQ

For assemblies, see codification below

SPACE QUALIFIED ASSEMBLIES (SQ)

A part number is given for each different length size. For this reason, a codification method is presented to simplify the configuration.

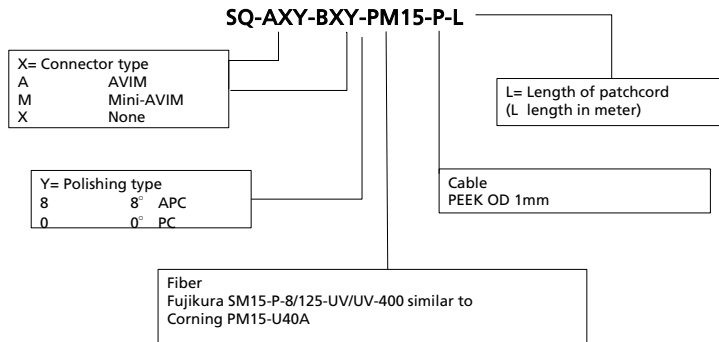

- Examples** SQ-AM8-BM8-PM15-P-2.1 patchcord L=2.1m with PM fiber 1550nm, PEEK loose tube OD 1mm, 2x Mini-AVIM APC
- SQ-AA8-BM8-PM15-P-1.5 patchcord L=1.5m with PM fiber 1550nm, PEEK loose tube OD 1mm, 1x AVIM APC, 1x Mini-AVIM APC

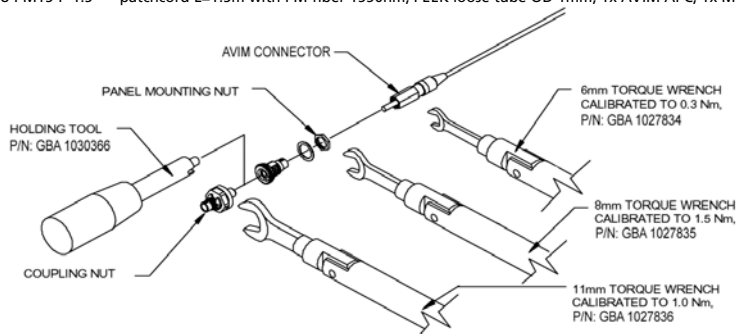

Mini-AVIM FAMILY

Mini-AVIM

Mini-AVIM Mating Adapter Standard P/Ns	
Order Number	Description (Type designation)
EBN 1058232	Mini-AVIM mating adapter square flange
EJB 1062148	IMOD PC 0°
EOX 1059841	MAS Univ. Adapter
ECC 1065927	Hybrid Adapter Mini-AVIM/DMI
ECH 1064074	Hybrid adapter Mini-AVIM / AVIM

Mini-AVIM Interconnection tools P/Ns	
Order Number	Description (Type designation)
GBA 1060037	6.5 mm Torque wrench calibrated to 0.3 Nm (For torquing Mini-AVIM Connector)
GBC 1060258	Mini-AVIM Un-mounting tool

Mini-AVIM Space Qualified P/N:	
Order Number	Description (Type designation)
EBN 1070158	Mini-AVIM mating adapter square flange SQ

For assemblies, see codification below

SPACE QUALIFIED ASSEMBLIES (SQ)

A part number is given for each different length size. For this reason, a codification method is presented to simplify the configuration.

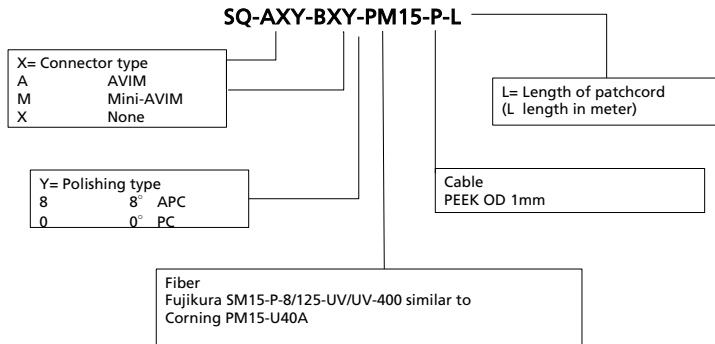

- Examples**
- SQ-AM8-BM8-PM15-P-2.1 patchcord L=2.1m with PM fiber 1550nm, PEEK loose tube OD 1mm, 2x Mini-AVIM APC
 - SQ-AA8-BM8-PM15-P-1.5 patchcord L=1.5m with PM fiber 1550nm, PEEK loose tube OD 1mm, 1x AVIM APC, 1x Mini-AVIM APC

Version 1114

FC FAMILY

FC STANDARD

FC STANDARD standard pigtail P/Ns		
Order Number	Description (Type designation, key ø, pigtail length)	Fiber
EMI 1034373	FC STANDARD MM PC standard pigtail, 2.14 mm, 2.5 m	50/125/900, ML OM3, turquoise
EMI 1034374	FC STANDARD MM PC standard pigtail, 2.14 mm, 2.5 m	62,5/125/900, TB, white
EMI 1034375	FC STANDARD SM PC standard pigtail, 2.14 mm, 2.5 m	9/125/900, TB, white
EMI 1034376	FC STANDARD SM PC standard pigtail, 2.14 mm, 2.5 m	9/125/900, ML, yellow
EMI 1034377	FC STANDARD SM APC standard pigtail, 2.14 mm, 2.5 m	9/125/900, TB, white
EMI 1034378	FC STANDARD SM APC standard pigtail, 2.14 mm, 2.5 m	9/125/900, ML, yellow

Notes: For other configurations, please refer to the Order information of the FC STANDARD datasheet.

FC STANDARD standard patchcord P/Ns		
Order Number	Description (Type designation, key ø, patch length)	Cable
ENI 1034379	FC STANDARD SM PC standard patchcord, 2.14 mm, 3 m	9/125/2.4 mm, yellow
ENI 1034380	FC STANDARD SM PC standard patchcord, 2.14 mm, 3 m	9/125/3.0 mm, yellow
ENI 1034381	FC STANDARD SM PC standard patchcord, 2.14 mm, 5 m	9/125/2.4 mm, yellow
ENI 1034382	FC STANDARD SM PC standard patchcord, 2.14 mm, 5 m	9/125/3.0 mm, yellow
ENI 1034383	FC STANDARD SM APC standard patchcord, 2.14 mm, 3 m	9/125/2.4 mm, yellow
ENI 1034384	FC STANDARD SM APC standard patchcord, 2.14 mm, 3 m	9/125/3.0 mm, yellow
ENI 1034385	FC STANDARD SM APC standard patchcord, 2.14 mm, 5 m	9/125/2.4 mm, yellow
ENI 1034386	FC STANDARD SM APC standard patchcord, 2.14 mm, 5 m	9/125/3.0 mm, yellow

Notes: For other configurations, please refer to the Order information of the FC STANDARD datasheet.
2.4mm cable is LSOH; 3.0mm is OFNR.

FC MATING ADAPTERS

FC Mating Adapters Standard P/Ns	
Order Number	Description (Type designation, key ø)
Square flange type	
EBI 1015581	FC mating adapter MM, key 2.2 mm
EBI 1015556	FC mating adapter SM PC, key 2.2 mm
EBI 1015565	FC mating adapter SM APC, key 2 mm
EBI 1015564	FC mating adapter SM APC, key 2.2 mm
Hexagonal flange type	
EBI 1015580	FC mating adapter MM, key 2.2 mm
EBI 1015560	FC mating adapter SM PC, key 2.2 mm
EBI 1015570	FC mating adapter SM APC, key 2 mm
EBI 1015561	FC mating adapter SM APC, key 2.2 mm
Round flange type	
EBI 1015589	FC mating adapter MM, key 2.2 mm
EBI 1015566	FC mating adapter SM PC, key 2.2 mm
EBI 1015571	FC mating adapter SM APC, key 2 mm
EBI 1015555	FC mating adapter SM APC, key 2.2 mm

Note: other versions upon request.

ST™ FAMILY**ST™ STANDARD**

ST™ Standard standard patchcord P/Ns		
Order Number	Description (Type designation, patch length)	Cable
ENK 1034387	ST™ STANDARD SM PC standard patchcord, 3 m	9/125/2.4 mm, yellow
ENK 1034388	ST™ STANDARD SM PC standard patchcord, 3 m	9/125/3.0 mm, yellow
ENK 1034389	ST™ STANDARD SM PC standard patchcord, 5 m	9/125/2.4 mm, yellow
ENK 1034390	ST™ STANDARD SM PC standard patchcord, 5 m	9/125/3.0 mm, yellow

Notes: For other configurations, please refer to the Order information of the ST™ STANDARD datasheet.
2.4mm cable is LSOH; 3.0mm is OFNR.

ST™ MATING ADAPTERS

ST™ Mating Adapters Standard P/Ns	
Order Number	Description (Type designation, material)
EBK 1016061	ST™ mating adapters MM, Metal. (suitable for Standard, Fusion, Crimp & Cleave version)
EBK 1016059	ST™ mating adapters SM, Metal. (suitable for Standard, Fusion, Crimp & Cleave version)
EBK 1015839	ST™ mating adapters MM, Plastic. (suitable for Fusion, Crimp & Cleave version)
EBK 1016060	ST™ mating adapters SM, Plastic. (suitable for Fusion, Crimp & Cleave version)

Note: Plastic type suitable only for ST™ Alberino and Fusion connectors

Version 129

DMI (Diamond Micro Interface)

DMI Mating Adapters Standard P/Ns	
Order Number	Description (Type designation, cap color)
EBN 1027427	DMI mating adapter MM PC, black
EBN 1019156	DMI mating adapter SM PC, blue
EBN 1016506	DMI mating adapter SM APC, green
DAB 1009209	DMI mating adapter clip
EZ 1063581	DMI mounting set for clip (Screw M2 x 5mm A4 INOX ISO7380; Nut DIN934 INOX)
GBC 1032053	DMI mounting tool

DMI Mounting Instructions

Fixing DMI assembling onto the clip:

- 1) Position one lateral site of DMI assembly into the clip
(be sure that the V-Groove of DMIconnector is correct (see detail))
- 2) Position the DMI on the other side of DMI assembly and press down on DMI clip

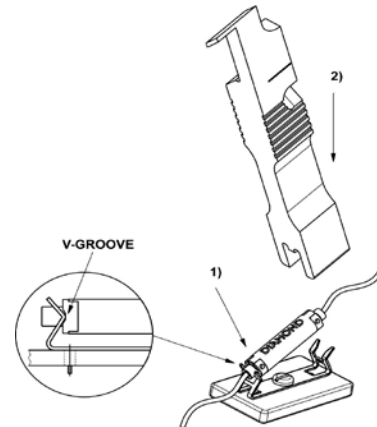

Releasing DMI assembling from the clip:

- 1) Position DMI tool between DMI assembly and clip
- 2) Push the DMI tool down to release the DMI assembly

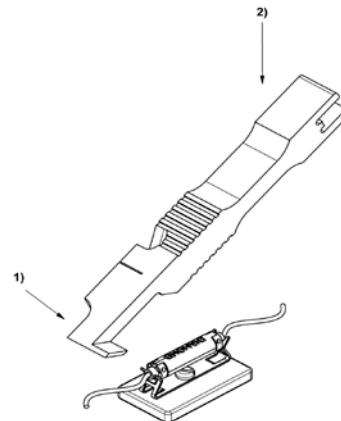

Uncoupling of DMI connector from mating adapter:

- 1) Position DMI assembly on DMI tool.
(Be sure that the blade of DMI tool is positioned between DMI adapter and connector)
- 2) Pull the DMI assembly to uncouple connector from adapter

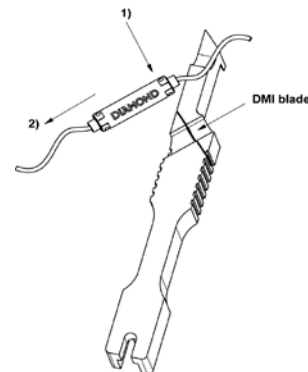

F-SMA

F-SMA Mating Adapter Standard P/Ns	
Order Number	Description (Type designation)
EBJ 1015641	F-SMA mating adapter
EJB 1077637	IMOD F-SMA

Version 125

DIAMOND FAMILY

DIAMOND HFS-13

DIAMOND HFS-13 Mating Adapters Standard P/Ns	
Order Number	Description (Type designation)
EBL 1015835	DIAMOND MST-13 mating adapter
EBL 1027257	DIAMOND MST-13 /B mating adapter

Version 015

DIAMOND HFS-3

DIAMOND HFS-3 Mating Adapters Standard P/Ns	
Order Number	Description (Type designation)
EBL 1015838	DIAMOND MST-3 mating adapter
EBL 1027259	DIAMOND MST-3 /B mating adapter

Version 015

DIAMOND HMS-10

DIAMOND HMS-10 Mating Adapters Standard P/Ns	
Order Number	Description (Type designation)
EBL 1015834	DIAMOND MMT-10 mating adapter
EBL 1015836	DIAMOND MMT-10 /B mating adapter

Version 015

DIAMOND HMS-0

DIAMOND HMS-0 Mating Adapters Standard P/Ns	
Order Number	Description (Type designation)
EBL 1015837	DIAMOND MMT-0 mating adapter
EBL 1027258	DIAMOND MMT-0 /B mating adapter

Version 015

MT-RJ FAMILY

MT-RJ Standard patchcord P/Ns		
Order Number	Description (Type designation, patch length)	Cable
MT-RJ male (with pins)		
ENE 1027652	MT-RJ male MM PC, standard patchcord, 3 m	50/125/1.8 / 3.6 mm, orange (Mini Zip Cord)
ENE 1027653	MT-RJ male MM PC, standard patchcord, 5 m	50/125/1.8 / 3.6 mm, orange (Mini Zip Cord)
MT-RJ female (without pins)		
ENE 1027656	MT-RJ female SM PC, standard patchcord, 3 m	9/125/1.8 / 3.6 mm, yellow (Mini Zip Cord)
ENE 1027657	MT-RJ female SM PC, standard patchcord, 5 m	9/125/1.8 / 3.6 mm, yellow (Mini Zip Cord)
MT-RJ female (without pins)		
ENE 1027659	MT-RJ female MM PC, standard patchcord, 3 m	50/125/1.8 / 3.6 mm, orange (Mini Zip Cord)
ENE 1023760	MT-RJ female MM PC, standard patchcord, 5 m	50/125/1.8 / 3.6 mm, orange (Mini Zip Cord)
ENE 1021582	MT-RJ female SM PC, standard patchcord, 3 m	9/125/1.8 / 3.6 mm, yellow (Mini Zip Cord)
ENE 1027661	MT-RJ female SM PC, standard patchcord, 5 m	9/125/1.8 / 3.6 mm, yellow (Mini Zip Cord)

Notes: For other configurations, please refer to the Order information of the MT-RJ datasheet.
SM cable is LSOH and MM cable is FRNC.

MT-RJ Mating Adapters Standard P/Ns	
Order Number	Description (Type designation, housing colors)
EBE 1019153	MT-RJ mating adapter MM, black (M2 x 8 mm steel)
EBE 1019154	MT-RJ mating adapter SM, blue (M2 x 8 mm steel)

Version 015

MFS (Multiple Fiber System)

MFS Mating Adapters & PCB/Backplane Modules Standard P/Ns	
Order Number	Description (Type designation, housing colors)
Mating Adapters (MF-A3)	
EBD 1027422	MF-A3 Mating Adapter MM PC, beige (M2 x 8 mm steel)
EBD 1019163	MF-A3 Mating Adapter SM PC, blue (M2 x 8 mm steel)
EBD 1019151	MF-A3 Mating Adapter SM APC, green (M2 x 8 mm steel)
PCB Modules (MF-B2)	
DAE 1027425	MF-B2 PCB Module MM PC, beige
DAE 1009442	MF-B2 PCB Module SM PC, blue
DAE 1009443	MF-B2 PCB Module SM APC, green
Backplane Modules (MF-B3)	
DAE 1027426	MF-B3 Backplane Module MM PC, beige
DAE 1009437	MF-B3 Backplane Module SM PC, blue
DAE 1009436	MF-B3 Backplane Module SM APC, green
GBA 1024226	Extraction tool for MF-A2 and MF-B1 on MF-B3 & MF-B2

Version 115

MPO

MPO Mating Adapter Standard P/N	
Order Number	Description (Type designation, housing color)
EBO 1005103	MPO mating adapter, black (suitable for MM & SM PC/APC)

Version 015

FUSION

E-2000™ FUSION

E-2000™ Fusion Connector Sets Standard (with BI-adhesive alberino) P/Ns		
Order Number	Description (Type designation, housing/straight boot colors, fiber type)	Fibre/Cable
E-2000™ Fusion Simplex		
EAA 1057246	E-2000™ Fusion simplex MM PC, beige / black, 50 µm	600 µm
EAA 1057247	E-2000™ Fusion simplex MM PC, beige / black, 50 µm	900 µm
EAA 1057248	E-2000™ Fusion simplex MM PC, beige / black, 50 µm	1.6 mm
EAA 1057249	E-2000™ Fusion simplex MM PC, beige / black, 50 µm	2.1 mm
EAA 1057250	E-2000™ Fusion simplex MM PC, beige / black, 50 µm	2.4 mm
EAA 1057251	E-2000™ Fusion simplex MM PC, beige / black, 50 µm	3.0 mm
EAA 1057309	E-2000™ Fusion simplex MM PC, beige / beige, 62.5 µm	600 µm
EAA 1057310	E-2000™ Fusion simplex MM PC, beige / beige, 62.5 µm	900 µm
EAA 1057311	E-2000™ Fusion simplex MM PC, beige / beige, 62.5 µm	1.6 mm
EAA 1057312	E-2000™ Fusion simplex MM PC, beige / beige, 62.5 µm	2.1 mm
EAA 1057313	E-2000™ Fusion simplex MM PC, beige / beige, 62.5 µm	2.4 mm
EAA 1057314	E-2000™ Fusion simplex MM PC, beige / beige, 62.5 µm	3.0 mm
EAA 1057315	E-2000™ Fusion simplex SM PC, blue / blue, 9 µm	600 µm
EAA 1057316	E-2000™ Fusion simplex SM PC, blue / blue, 9 µm	900 µm
EAA 1057317	E-2000™ Fusion simplex SM PC, blue / blue, 9 µm	1.6 mm
EAA 1057318	E-2000™ Fusion simplex SM PC, blue / blue, 9 µm	2.1 mm
EAA 1057319	E-2000™ Fusion simplex SM PC, blue / blue, 9 µm	2.4 mm
EAA 1057320	E-2000™ Fusion simplex SM PC, blue / blue, 9 µm	3.0 mm
EAA 1057321	E-2000™ Fusion simplex SM APC, green / green, 9 µm	600 µm
EAA 1057322	E-2000™ Fusion simplex SM APC, green / green, 9 µm	900 µm
EAA 1057323	E-2000™ Fusion simplex SM APC, green / green, 9 µm	1.6 mm
EAA 1057324	E-2000™ Fusion simplex SM APC, green / green, 9 µm	2.1 mm
EAA 1057325	E-2000™ Fusion simplex SM APC, green / green, 9 µm	2.4 mm
EAA 1057326	E-2000™ Fusion simplex SM APC, green / green, 9 µm	3.0 mm
E-2000™ Fusion Compact		
EAA 1057327	E-2000™ Fusion compact MM PC, beige / black, 50 µm	600 µm
EAA 1057328	E-2000™ Fusion compact MM PC, beige / black, 50 µm	900 µm
EAA 1057329	E-2000™ Fusion compact MM PC, beige / black, 50 µm	1.6 mm
EAA 1057330	E-2000™ Fusion compact MM PC, beige / black, 50 µm	2.1 mm
EAA 1057331	E-2000™ Fusion compact MM PC, beige / black, 50 µm	2.4 mm
EAA 1057332	E-2000™ Fusion compact MM PC, beige / black, 50 µm	3.0 mm
EAA 1057333	E-2000™ Fusion compact MM PC, beige / beige, 62.5 µm	600 µm
EAA 1057334	E-2000™ Fusion compact MM PC, beige / beige, 62.5 µm	900 µm
EAA 1057335	E-2000™ Fusion compact MM PC, beige / beige, 62.5 µm	1.6 mm
EAA 1057336	E-2000™ Fusion compact MM PC, beige / beige, 62.5 µm	2.1 mm
EAA 1057337	E-2000™ Fusion compact MM PC, beige / beige, 62.5 µm	2.4 mm
EAA 1057338	E-2000™ Fusion compact MM PC, beige / beige, 62.5 µm	3.0 mm
EAA 1057341	E-2000™ Fusion compact SM PC, blue / blue, 9 µm	600 µm
EAA 1057342	E-2000™ Fusion compact SM PC, blue / blue, 9 µm	900 µm
EAA 1057343	E-2000™ Fusion compact SM PC, blue / blue, 9 µm	1.6 mm
EAA 1057344	E-2000™ Fusion compact SM PC, blue / blue, 9 µm	2.1 mm
EAA 1057345	E-2000™ Fusion compact SM PC, blue / blue, 9 µm	2.4 mm
EAA 1057346	E-2000™ Fusion compact SM PC, blue / blue, 9 µm	3.0 mm
EAA 1057347	E-2000™ Fusion compact SM APC, green / green, 9 µm	600 µm
EAA 1057348	E-2000™ Fusion compact SM APC, green / green, 9 µm	900 µm
EAA 1057349	E-2000™ Fusion compact SM APC, green / green, 9 µm	1.6 mm
EAA 1057350	E-2000™ Fusion compact SM APC, green / green, 9 µm	2.1 mm
EAA 1057351	E-2000™ Fusion compact SM APC, green / green, 9 µm	2.4 mm
EAA 1057352	E-2000™ Fusion compact SM APC, green / green, 9 µm	3.0 mm

Note: other housing and boot colors, as well as fiber/cable types upon request.

For adapter and fixing clips ordering information, please refer to the respective part-specific E-2000™ Simplex, Compact Mating Adapter P/N lists.

Version 129

FUSION

F-3000™ FUSION

F-3000™ Fusion Connector Sets Standard (with BI-adhesive alberino) P/Ns

Order Number	Description (Type designation, housing/straight boot colors, fiber type)	Fibre/Cable
F-3000™ Fusion Simplex		
EAB 1057111	F-3000™ Fusion simplex MM PC, beige / black, 50 µm	600 µm
EAB 1057141	F-3000™ Fusion simplex MM PC, beige / black, 50 µm	900 µm
EAB 1057142	F-3000™ Fusion simplex MM PC, beige / black, 50 µm	1.6 mm
EAB 1057143	F-3000™ Fusion simplex MM PC, beige / black, 50 µm	2.1 mm
EAB 1057144	F-3000™ Fusion simplex MM PC, beige / black, 50 µm	2.4 mm
EAB 1057145	F-3000™ Fusion simplex MM PC, beige / black, 50 µm	3.0 mm
EAB 1057146	F-3000™ Fusion simplex MM PC, beige / beige, 62.5 µm	600 µm
EAB 1057147	F-3000™ Fusion simplex MM PC, beige / beige, 62.5 µm	900 µm
EAB 1057148	F-3000™ Fusion simplex MM PC, beige / beige, 62.5 µm	1.6 mm
EAB 1057149	F-3000™ Fusion simplex MM PC, beige / beige, 62.5 µm	2.1 mm
EAB 1057150	F-3000™ Fusion simplex MM PC, beige / beige, 62.5 µm	2.4 mm
EAB 1057151	F-3000™ Fusion simplex MM PC, beige / beige, 62.5 µm	3.0 mm
EAB 1057060	F-3000™ Fusion simplex SM PC, blue / blue, 9 µm	600 µm
EAB 1057092	F-3000™ Fusion simplex SM PC, blue / blue, 9 µm	900 µm
EAB 1057093	F-3000™ Fusion simplex SM PC, blue / blue, 9 µm	1.6 mm
EAB 1057094	F-3000™ Fusion simplex SM PC, blue / blue, 9 µm	2.1 mm
EAB 1057095	F-3000™ Fusion simplex SM PC, blue / blue, 9 µm	2.4 mm
EAB 1057096	F-3000™ Fusion simplex SM PC, blue / blue, 9 µm	3.0 mm
EAB 1055285	F-3000™ Fusion simplex SM APC, green / green, 9 µm	600 µm
EAB 1057097	F-3000™ Fusion simplex SM APC, green / green, 9 µm	900 µm
EAB 1055286	F-3000™ Fusion simplex SM APC, green / green, 9 µm	1.6 mm
EAB 1057098	F-3000™ Fusion simplex SM APC, green / green, 9 µm	2.1 mm
EAB 1057099	F-3000™ Fusion simplex SM APC, green / green, 9 µm	2.4 mm
EAB 1057100	F-3000™ Fusion simplex SM APC, green / green, 9 µm	3.0 mm
F-3000™ Fusion Duplex		
EAB 1057152	F-3000™ Fusion duplex MM PC, beige / black, 50 µm	600 µm
EAB 1057154	F-3000™ Fusion duplex MM PC, beige / black, 50 µm	900 µm
EAB 1057155	F-3000™ Fusion duplex MM PC, beige / black, 50 µm	1.6 mm
EAB 1057157	F-3000™ Fusion duplex MM PC, beige / black, 50 µm	2.1 mm
EAB 1057158	F-3000™ Fusion duplex MM PC, beige / black, 50 µm	2.4 mm
EAB 1057159	F-3000™ Fusion duplex MM PC, beige / black, 50 µm	3.0 mm
EAB 1057160	F-3000™ Fusion duplex MM PC, beige / beige, 62.5 µm	600 µm
EAB 1057161	F-3000™ Fusion duplex MM PC, beige / beige, 62.5 µm	900 µm
EAB 1057162	F-3000™ Fusion duplex MM PC, beige / beige, 62.5 µm	1.6 mm
EAB 1057163	F-3000™ Fusion duplex MM PC, beige / beige, 62.5 µm	2.1 mm
EAB 1057167	F-3000™ Fusion duplex MM PC, beige / beige, 62.5 µm	2.4 mm
EAB 1057170	F-3000™ Fusion duplex MM PC, beige / beige, 62.5 µm	3.0 mm
EAB 1057171	F-3000™ Fusion duplex SM PC, blue / blue, 9 µm	600 µm
EAB 1057172	F-3000™ Fusion duplex SM PC, blue / blue, 9 µm	900 µm
EAB 1057173	F-3000™ Fusion duplex SM PC, blue / blue, 9 µm	1.6 mm
EAB 1057174	F-3000™ Fusion duplex SM PC, blue / blue, 9 µm	2.1 mm
EAB 1057175	F-3000™ Fusion duplex SM PC, blue / blue, 9 µm	2.4 mm
EAB 1057176	F-3000™ Fusion duplex SM PC, blue / blue, 9 µm	3.0 mm
EAB 1057177	F-3000™ Fusion duplex SM APC, green / green, 9 µm	600 µm
EAB 1057181	F-3000™ Fusion duplex SM APC, green / green, 9 µm	900 µm
EAB 1057182	F-3000™ Fusion duplex SM APC, green / green, 9 µm	1.6 mm
EAB 1057183	F-3000™ Fusion duplex SM APC, green / green, 9 µm	2.1 mm
EAB 1057184	F-3000™ Fusion duplex SM APC, green / green, 9 µm	2.4 mm
EAB 1057185	F-3000™ Fusion duplex SM APC, green / green, 9 µm	3.0 mm

Note: other housing and boot colors, as well as fiber/cable types upon request.

For adapter and fixing clips ordering information, please refer to the respective part-specific F-3000™ Simplex, Duplex Mating Adapter P/N lists.

Version 024

F-3000™s FUSION

F-3000™s Fusion Connector Sets Standard (with BI-adhesive alberino) P/Ns

Order Number	Description (Type designation, housing/straight boot colors, fiber type)	Fibre/Cable
F-3000™ LCs Fusion Simplex		
EAB 1057186	F-3000™ s Fusion simplex MM PC, beige / black, 50 µm	600 µm
EAB 1057194	F-3000™ s Fusion simplex MM PC, beige / black, 50 µm	900 µm
EAB 1057195	F-3000™ s Fusion simplex MM PC, beige / black, 50 µm	1.6 mm
EAB 1057196	F-3000™ s Fusion simplex MM PC, beige / black, 50 µm	2.1 mm
EAB 1057198	F-3000™ s Fusion simplex MM PC, beige / black, 50 µm	2.4 mm
EAB 1057199	F-3000™ s Fusion simplex MM PC, beige / black, 50 µm	3.0 mm
EAB 1057200	F-3000™ s Fusion simplex MM PC, beige / beige, 62.5 µm	600 µm
EAB 1057202	F-3000™ s Fusion simplex MM PC, beige / beige, 62.5 µm	900 µm
EAB 1057203	F-3000™ s Fusion simplex MM PC, beige / beige, 62.5 µm	1.6 mm
EAB 1057204	F-3000™ s Fusion simplex MM PC, beige / beige, 62.5 µm	2.1 mm
EAB 1057206	F-3000™ s Fusion simplex MM PC, beige / beige, 62.5 µm	2.4 mm
EAB 1057208	F-3000™ s Fusion simplex MM PC, beige / beige, 62.5 µm	3.0 mm
EAB 1057210	F-3000™ s Fusion simplex SM PC, blue / blue, 9 µm	600 µm
EAB 1057211	F-3000™ s Fusion simplex SM PC, blue / blue, 9 µm	900 µm
EAB 1057212	F-3000™ s Fusion simplex SM PC, blue / blue, 9 µm	1.6 mm
EAB 1057213	F-3000™ s Fusion simplex SM PC, blue / blue, 9 µm	2.1 mm
EAB 1057214	F-3000™ s Fusion simplex SM PC, blue / blue, 9 µm	2.4 mm
EAB 1057215	F-3000™ s Fusion simplex SM PC, blue / blue, 9 µm	3.0 mm
EAB 1055287	F-3000™ s Fusion simplex SM APC, green / green, 9 µm	600 µm
EAB 1057217	F-3000™ s Fusion simplex SM APC, green / green, 9 µm	900 µm
EAB 1055288	F-3000™ s Fusion simplex SM APC, green / green, 9 µm	1.6 mm
EAB 1057218	F-3000™ s Fusion simplex SM APC, green / green, 9 µm	2.1 mm
EAB 1057219	F-3000™ s Fusion simplex SM APC, green / green, 9 µm	2.4 mm
EAB 1057220	F-3000™ s Fusion simplex SM APC, green / green, 9 µm	3.0 mm
F-3000™ s Fusion Duplex		
EAB up on request	F-3000™ s Fusion duplex MM PC, beige / black, 50 µm	600 µm
EAB up on request	F-3000™ s Fusion duplex MM PC, beige / black, 50 µm	900 µm
EAB up on request	F-3000™ s Fusion duplex MM PC, beige / black, 50 µm	1.6 mm
EAB up on request	F-3000™ s Fusion duplex MM PC, beige / black, 50 µm	2.1 mm
EAB up on request	F-3000™ s Fusion duplex MM PC, beige / black, 50 µm	2.4 mm
EAB up on request	F-3000™ s Fusion duplex MM PC, beige / black, 50 µm	3.0 mm
EAB up on request	F-3000™ s Fusion duplex MM PC, beige / beige, 62.5 µm	600 µm
EAB up on request	F-3000™ s Fusion duplex MM PC, beige / beige, 62.5 µm	900 µm
EAB up on request	F-3000™ s Fusion duplex MM PC, beige / beige, 62.5 µm	1.6 mm
EAB up on request	F-3000™ s Fusion duplex MM PC, beige / beige, 62.5 µm	2.1 mm
EAB up on request	F-3000™ s Fusion duplex MM PC, beige / beige, 62.5 µm	2.4 mm
EAB up on request	F-3000™ s Fusion duplex MM PC, beige / beige, 62.5 µm	3.0 mm
EAB up on request	F-3000™ s Fusion duplex SM PC, blue / blue, 9 µm	600 µm
EAB up on request	F-3000™ s Fusion duplex SM PC, blue / blue, 9 µm	900 µm
EAB up on request	F-3000™ s Fusion duplex SM PC, blue / blue, 9 µm	1.6 mm
EAB up on request	F-3000™ s Fusion duplex SM PC, blue / blue, 9 µm	2.1 mm
EAB up on request	F-3000™ s Fusion duplex SM PC, blue / blue, 9 µm	2.4 mm
EAB up on request	F-3000™ s Fusion duplex SM PC, blue / blue, 9 µm	3.0 mm
EAB up on request	F-3000™ s Fusion duplex SM APC, green / green, 9 µm	600 µm
EAB up on request	F-3000™ s Fusion duplex SM APC, green / green, 9 µm	900 µm
EAB up on request	F-3000™ s Fusion duplex SM APC, green / green, 9 µm	1.6 mm
EAB up on request	F-3000™ s Fusion duplex SM APC, green / green, 9 µm	2.1 mm
EAB up on request	F-3000™ s Fusion duplex SM APC, green / green, 9 µm	2.4 mm
EAB up on request	F-3000™ s Fusion duplex SM APC, green / green, 9 µm	3.0 mm

Note: other housing and boot colors, as well as fiber/cable types upon request.

For adapter and fixing clips ordering information, please refer to the respective part-specific F-3000™ Simplex, Duplex Mating Adapter P/N lists.

Version 024

SC FUSION

SC Fusion Connector Sets Standard (with BI-adhesive alberlno) P/Ns		
Order Number	Description (Type designation, housing/straight boot colors, fiber type)	Fibre/Cable
EAC 1057353	SC Fusion MM PC, beige / black, 50 µm	600 µm
EAC 1057354	SC Fusion MM PC, beige / black, 50 µm	900 µm
EAC 1057355	SC Fusion MM PC, beige / black, 50 µm	1.6 mm
EAC 1057356	SC Fusion MM PC, beige / black, 50 µm	2.1 mm
EAC 1057357	SC Fusion MM PC, beige / black, 50 µm	2.4 mm
EAC 1057358	SC Fusion MM PC, beige / black, 50 µm	3.0 mm
EAC 1057359	SC Fusion MM PC, beige / beige, 62.5 µm	600 µm
EAC 1057360	SC Fusion MM PC, beige / beige, 62.5 µm	900 µm
EAC 1057361	SC Fusion MM PC, beige / beige, 62.5 µm	1.6 mm
EAC 1057362	SC Fusion MM PC, beige / beige, 62.5 µm	2.1 mm
EAC 1057363	SC Fusion MM PC, beige / beige, 62.5 µm	2.4 mm
EAC 1057364	SC Fusion MM PC, beige / beige, 62.5 µm	3.0 mm
EAC 1057365	SC Fusion SM PC, blue / blue, 9 µm	600 µm
EAC 1057366	SC Fusion SM PC, blue / blue, 9 µm	900 µm
EAC 1057367	SC Fusion SM PC, blue / blue, 9 µm	1.6 mm
EAC 1057368	SC Fusion SM PC, blue / blue, 9 µm	2.1 mm
EAC 1057369	SC Fusion SM PC, blue / blue, 9 µm	2.4 mm
EAC 1057370	SC Fusion SM PC, blue / blue, 9 µm	3.0 mm
EAC 1057371	SC Fusion SM APC, green / green, 9 µm	600 µm
EAC 1057372	SC Fusion SM APC, green / green, 9 µm	900 µm
EAC 1057373	SC Fusion SM APC, green / green, 9 µm	1.6 mm
EAC 1057374	SC Fusion SM APC, green / green, 9 µm	2.1 mm
EAC 1057375	SC Fusion SM APC, green / green, 9 µm	2.4 mm
EAC 1057376	SC Fusion SM APC, green / green, 9 µm	3.0 mm

Note: other boot colors, as well as fiber/cable types upon request.

For adapter ordering information, please refer to the respective part-specific SC Mating Adapter P/N list.

Version 129

FC FUSION

FC Fusion Connector Sets Standard (with BI-adhesive alberino) P/Ns		
Order Number	Description (Type designation, key ø, straight boot colors, fiber type)	Fibre/Cable
EAI 1062948	FC Fusion MM PC, 2.14 mm, black, 50 µm	900 µm
EAI 1062949	FC Fusion MM PC, 2.14 mm, black, 50 µm	1.6 mm
EAI 1062951	FC Fusion MM PC, 2.14 mm, black, 50 µm	2.1 mm
EAI 1062953	FC Fusion MM PC, 2.14 mm, black, 50 µm	2.4 mm
EAI 1062954	FC Fusion MM PC, 2.14 mm black, 50 µm	3.0 mm
EAI 1062957	FC Fusion MM PC, 2.14 mm, beige, 62.5 µm	900 µm
EAI 1062958	FC Fusion MM PC, 2.14 mm, beige, 62.5 µm	1.6 mm
EAI 1062959	FC Fusion MM PC, 2.14 mm, beige, 62.5 µm	2.1 mm
EAI 1062963	FC Fusion MM PC, 2.14 mm, beige, 62.5 µm	2.4 mm
EAI 1062964	FC Fusion MM PC, 2.14 mm, beige, 62.5 µm	3.0 mm
EAI 1062931	FC Fusion SM PC, 2.14 mm, blue, 9 µm	900 µm
EAI 1062932	FC Fusion SM PC, 2.14 mm, blue, 9 µm	1.6 mm
EAI 1062933	FC Fusion SM PC, 2.14 mm, blue, 9 µm	2.1 mm
EAI 1062934	FC Fusion SM PC, 2.14 mm, blue, 9 µm	2.4 mm
EAI 1062935	FC Fusion SM PC, 2.14 mm, blue, 9 µm	3.0 mm
EAI 1062943	FC Fusion SM APC, 2 mm, green, 9 µm (JDS)	900 µm
EAI 1062944	FC Fusion SM APC, 2 mm, green, 9 µm (JDS)	1.6 mm
EAI 1062945	FC Fusion SM APC, 2 mm, green, 9 µm (JDS)	2.1 mm
EAI 1062946	FC Fusion SM APC, 2 mm, green, 9 µm (JDS)	2.4 mm
EAI 1062947	FC Fusion SM APC, 2 mm, green, 9 µm (JDS)	3.0 mm
EAI 1062936	FC Fusion SM APC, 2.14 mm, green, 9 µm	900 µm
EAI 1062937	FC Fusion SM APC, 2.14 mm, green, 9 µm	1.6 mm
EAI 1062938	FC Fusion SM APC, 2.14 mm, green, 9 µm	2.1 mm
EAI 1062939	FC Fusion SM APC, 2.14 mm, green, 9 µm	2.4 mm
EAI 1062940	FC Fusion SM APC, 2.14 mm, green, 9 µm	3.0 mm

Note: other boot colors, as well as fiber/cable types upon request.

For adapter ordering information, please refer to the respective part-specific FC Mating Adapter P/N list.

Version 031

ST™ FUSION

ST™ Fusion Connector Sets Standard (with BI-adhesive alberlno) P/Ns		
Order Number	Description (Type designation, straight boot colors, fiber type)	Fibre/Cable
EAK 1062911	ST™ Fusion MM PC, black, 50 µm	900 µm
EAK 1062903	ST™ Fusion MM PC, black, 50 µm	1.6 mm
EAK 1062902	ST™ Fusion MM PC, black, 50 µm	2.1 mm
EAK 1062909	ST™ Fusion MM PC, black, 50 µm	2.4 mm
EAK 1062910	ST™ Fusion MM PC, black, 50 µm	3.0 mm
EAK 1062912	ST™ Fusion MM PC, beige, 62.5 µm	900 µm
EAK 1062913	ST™ Fusion MM PC, beige, 62.5 µm	1.6 mm
EAK 1062914	ST™ Fusion MM PC, beige, 62.5 µm	2.1 mm
EAK 1062915	ST™ Fusion MM PC, beige, 62.5 µm	2.4 mm
EAK 1062917	ST™ Fusion MM PC, beige, 62.5 µm	3.0 mm
EAK 1062898	ST™ Fusion SM PC, blue, 9 µm	900 µm
EAK 1062904	ST™ Fusion SM PC, blue, 9 µm	1.6 mm
EAK 1062906	ST™ Fusion SM PC, blue, 9 µm	2.1 mm
EAK 1062907	ST™ Fusion SM PC, blue, 9 µm	2.4 mm
EAK 1062908	ST™ Fusion SM PC, blue, 9 µm	3.0 mm

Note: other boot colors, as well as fiber/cable types upon request.

For adapter ordering information, please refer to the respective part-specific ST™ Mating Adapter P/N list.

Version 031

FUSION

Crocodile Splice Unit sets for cables

Crocodile Splice Unit sets, Standards P/Ns for cable with fiber $\varnothing \geq 250 / \leq 400 \mu\text{m}$		
Order Number	Description (Type designation, housing/straight boot colors)	Cable
EAZ 1060789	Crocodile Splice Unit set, grey / black	<2.0 mm
EAZ 1060790	Crocodile Splice Unit set, grey / black	2.0 - 2.1 mm
EAZ 1060791	Crocodile Splice Unit set, grey / black	2.1 - 2.5 mm
EAZ 1060792	Crocodile Splice Unit set, grey / black	2.5 - 3.0 mm

Note: other housing and boot colors, as well as fiber/cable types upon request.

Crocodile Splice Unit sets, Standards P/Ns for cable with fiber $\varnothing > 400 / \leq 600 \mu\text{m}$		
Order Number	Description (Type designation, housing/straight boot colors)	Cable
EAZ 1060764	Crocodile Splice Unit set, grey / black	<2.0 mm
EAZ 1060765	Crocodile Splice Unit set, grey / black	2.0 - 2.1 mm
EAZ 1060766	Crocodile Splice Unit set, grey / black	2.1 - 2.5 mm
EAZ 1060767	Crocodile Splice Unit set, grey / black	2.5 - 3.0 mm

Note: other housing and boot colors, as well as fiber/cable types upon request.

Crocodile Splice Unit sets, Standards P/Ns for cable with fiber $\varnothing > 600 / \leq 900 \mu\text{m}$		
Order Number	Description (Type designation, housing/straight boot colors)	Cable
EAZ 1060786	Crocodile Splice Unit set, grey / black	<2.0 mm
EAZ 1059826	Crocodile Splice Unit set, grey / black	2.0 - 2.1 mm
EAZ 1060787	Crocodile Splice Unit set, grey / black	2.1 - 2.5 mm
EAZ 1060788	Crocodile Splice Unit set, grey / black	2.5 - 3.0 mm

Note: other housing and boot colors, as well as fiber/cable types upon request.

Crocodile Splice Unit sets for fibers

Crocodile Splice Unit sets, Standards P/Ns for fiber $\varnothing \geq 250 / \leq 900 \mu\text{m}$		
Order Number	Description (Type designation, housing colors)	Fiber
EAZ 1059398	Crocodile Splice Unit set, red	$\varnothing \geq 250 / \leq 400 \mu\text{m}$
EAZ 1059600	Crocodile Splice Unit set, beige	$\varnothing > 400 / \leq 900 \mu\text{m}$

Note: other fiber types upon request.

Crocodile Splice Unit Tool Kit	
Order Number	Description
FBD 1059847	Special crocodile holder for fiber and cable, to be used with ZEUS D50 Fusion Kit

For ZEUS D50 ordering information, please refer to the respective part-specific ZEUS D50 fusion field termination kit P/N list.

Version 100

CRIMP & CLEAVE

E-2000™ CRIMP & CLEAVE

E-2000™ Crimp & Cleave Connector Sets Standard P/Ns		
Order Number	Description (Type designation, housing/straight boot colors, fiber type)	Fibre/Cable
EAA 1039534	E-2000™ Crimp & Cleave simplex, black / black, HCS 200-230 µm	900 µm
EAA 1039535	E-2000™ Crimp & Cleave simplex, black / black, HCS 200-230 µm	1.6 mm
EAA 1039536	E-2000™ Crimp & Cleave simplex, black / black, HCS 200-230 µm	2.1 mm
EAA 1039537	E-2000™ Crimp & Cleave simplex, black / black, HCS 200-230 µm	2.4 mm
EAA 1039538	E-2000™ Crimp & Cleave simplex, black / black, HCS 200-230 µm	3.0 mm
EAA 1039539	E-2000™ Crimp & Cleave Compact, black / black, HCS 200-230 µm	900 µm
EAA 1039540	E-2000™ Crimp & Cleave Compact, black / black, HCS 200-230 µm	1.6 mm
EAA 1039541	E-2000™ Crimp & Cleave Compact, black / black, HCS 200-230 µm	2.1 mm
EAA 1039542	E-2000™ Crimp & Cleave Compact, black / black, HCS 200-230 µm	2.4 mm
EAA 1039543	E-2000™ Crimp & Cleave Compact, black / black, HCS 200-230 µm	3.0 mm

Note: other housing and boot colors, as well as fiber/cable types upon request.

E-2000™ Crimp & Cleave Mating Adapters Standard P/Ns (New generation)	
Order Number	Description (Type designation, housing/frame colors, fixing type)
EBA 1047248	E-2000™ simplex Crimp & Cleave mating adapter, black / black, without fixation
EBA 1047249	E-2000™ simplex Crimp & Cleave mating adapter, black / black, screw fixing clip (M2 x 8 mm steel)
EBA 1047250	E-2000™ simplex Crimp & Cleave mating adapter, black / black, quick fixing clip (Type a, 1 piece)
EBA 1047251	E-2000™ simplex Crimp & Cleave mating adapter, black / black, quick fixing clip (Type b, 2 pieces)
EBA 1047252	E-2000™ simplex Crimp & Cleave mating adapter, black / black, print fixing clip (6 pins)
EBA 1047253	E-2000™ Compact Crimp & Cleave mating adapter, black / black, without fixation
EBA 1047254	E-2000™ Compact Crimp & Cleave mating adapter, black / black, screw fixing clip (M" x 8 mm steel)
EBA 1047255	E-2000™ Compact Crimp & Cleave mating adapter, black / black, quick fixing clip (2 pieces needed)
EBA 1047256	E-2000™ Compact Crimp & Cleave mating adapter, black / black, print fixing clip (snap closure)
EBA 1047257	E-2000™ Compact Crimp & Cleave mating adapter, black / black, print fixing clip (6 pins)

Note: other housing and frame colors upon request

E-2000™ IP 65 Crimp & Cleave Mating Adapters Standard P/Ns (New generation)	
Order Number	Description (Type designation, housing/frame colors, fixing type)
EBA 1053667	E-2000™ IP 65 simplex Crimp & Cleave mating adapter, black / black, without fixation
EBA 1053668	E-2000™ IP 65 simplex Crimp & Cleave mating adapter, black / black, screw fixing clip (M2 x 8 mm steel)
EBA 1053669	E-2000™ IP 65 simplex Crimp & Cleave mating adapter, black / black, quick fixing clip (Type a, 1 piece)
EBA 1053670	E-2000™ IP 65 simplex Crimp & Cleave mating adapter, black / black, quick fixing clip (Type b, 2 pieces)
EBA 1053671	E-2000™ IP 65 compact Crimp & Cleave mating adapter, black / black, without fixation
EBA 1053672	E-2000™ IP 65 compact Crimp & Cleave mating adapter, black / black, screw fixing clip (M2 x 8 mm steel)
EBA 1053673	E-2000™ IP 65 compact Crimp & Cleave mating adapter, black / black, quick fixing clip (2 pieces needed)

Notes: every 100 E-2000™ mating adapters IP 65, a service adapter (GBC 1019034) for O' Ring mounting will be added

Other housing and frame colors upon request

E-2000™ Crimp & Cleave Mating Adapter fixing clips P/Ns	
Order Number	Description
E-2000™ Simplex mating adapter fixing clips	
DA# 1012081	Screw fixing clip
DA# 1012082	Quick fixing clip (Type a, 1 piece)
DA# 1012202	Quick fixing clip (Type b, 2 pieces)
DAB 1012091	Print fixing clip (6 pins)
E-2000™ Compact mating adapter fixing clips	
DA# 1012078	Screw fixing clip
DA# 1022803	Quick fixing clip (2 pieces needed)
DA# 1012080	Print fixing clip (snap closure)
DAB 1012090	Print fixing clip (6 pins)

Note: other fixation types upon request

CRIMP & CLEAVE TERMINATION KIT

Crimp & Cleave Termination Kit, tooling & options P/Ns	
Order Number	Description
GBA 1038642	Termination Kit including E-2000™ pliers
GBC 1038284	Fiber cleaver
FBA 1038295	Crimp tool
BCC 1020713	Scissors
GBA 1019341	Cable stripper
BCC 1039756	Fiber stripper
Option pliers for housing assembly	
GBA 1019297	SC plier
GBA 1019413	FC plier
GBA 1019414	ST™ plier

Version 031

SC CRIMP & CLEAVE

SC Crimp & Cleave Connector Sets Standard P/Ns

Order Number	Description (Type designation, housing/straight boot colors, fiber type)	Fibre/Cable
EAC 1039544	SC Crimp & Cleave, black / black, HCS 200-230 µm	900 µm
EAC 1039545	SC Crimp & Cleave, black / black, HCS 200-230 µm	1.6 mm
EAC 1039546	SC Crimp & Cleave, black / black, HCS 200-230 µm	2.1 mm
EAC 1039547	SC Crimp & Cleave, black / black, HCS 200-230 µm	2.4 mm
EAC 1039548	SC Crimp & Cleave, black / black, HCS 200-230 µm	3.0 mm

Note: other housing and boot colors, as well as fiber/cable types upon request. SC C&C Duplex version also available upon request.

SC Crimp & Cleave Mating Adapters Standard P/Ns

Order Number	Description (Type designation, housing colors, fixing type)
EBC 1027304	SC Crimp & Cleave mating adapter, black , screw & clip fixing type (M2 x 8 mm steel)
EBC 1021616	SC Crimp & Cleave mating adapter, black, screw-nut fixation (M2 x 8 mm steel)

Note: other fixation types upon request.

CRIMP & CLEAVE TERMINATION KIT

Crimp & Cleave Termination Kit, tooling & options P/Ns

Order Number	Description
GBA 1038642	Termination Kit including E-2000™ pliers
GBC 1038284	Fiber cleaver
FBA 1038295	Crimp tool
BCC 1020713	Scissors
GBA 1019341	Cable stripper
BCC 1039756	Fiber stripper
Option pliers for housing assembly	
GBA 1019297	SC plier
GBA 1019413	FC plier
GBA 1019414	ST™ plier

Version 088

FC CRIMP & CLEAVE

FC Crimp & Cleave Connector Sets Standard P/Ns

Order Number	Description (Type designation, key ø, straight boot colors, fiber type)	Fibre/Cable
EAI 1039549	FC Crimp & Cleave, 2.14 mm, black, HCS 200-230 µm	900 µm
EAI 1039550	FC Crimp & Cleave, 2.14 mm, black, HCS 200-230 µm	1.6 mm
EAI 1039551	FC Crimp & Cleave, 2.14 mm, black, HCS 200-230 µm	2.1 mm
EAI 1039552	FC Crimp & Cleave, 2.14 mm, black, HCS 200-230 µm	2.4 mm
EAI 1039553	FC Crimp & Cleave, 2.14 mm, black, HCS 200-230 µm	3.0 mm

Note: other boot colors, as well as fiber/cable types upon request.

FC Crimp & Cleave Mating Adapters Standard P/Ns

Order Number	Description (Type designation, key ø)
EBI 1015581	FC Crimp & Cleave mating adapter Square flange, key 2.2 mm
EBI 1015580	FC Crimp & Cleave mating adapter Hexagonal flange, key 2.2 mm
EBI 1015589	FC Crimp & Cleave mating adapter Round flange, key 2.2 mm

Note: other types upon request.

CRIMP & CLEAVE TERMINATION KIT

Crimp & Cleave Termination Kit, tooling & options P/Ns

Order Number	Description
GBA 1038642	Termination Kit including E-2000™ pliers
GBC 1038284	Fiber cleaver
FBA 1038295	Crimp tool
BCC 1020713	Scissors
GBA 1019341	Cable stripper
BCC 1039756	Fiber stripper
Option pliers for housing assembly	
GBA 1019297	SC plier
GBA 1019413	FC plier
GBA 1019414	ST™ plier

Version 088

ST™ CRIMP & CLEAVE

ST™ Crimp & Cleave Connector Sets Standard P/Ns		
Order Number	Description (Type designation, straight boot colors, fiber type)	Fibre/Cable
EAK 1039554	ST™ Crimp & Cleave, black, HCS 200-230 µm	900 µm
EAK 1039555	ST™ Crimp & Cleave, black, HCS 200-230 µm	1.6 mm
EAK 1039556	ST™ Crimp & Cleave, black, HCS 200-230 µm	2.1 mm
EAK 1039557	ST™ Crimp & Cleave, black, HCS 200-230 µm	2.4 mm
EAK 1039558	ST™ Crimp & Cleave, black, HCS 200-230 µm	3.0 mm

Note: other boot colors, as well as fiber/cable types upon request.

ST™ Crimp & Cleave Mating Adapters Standard P/Ns	
Order Number	Description (Type designation, material)
EBK 1015839	ST™ Crimp & Cleave mating adapter, plastic

CRIMP & CLEAVE TERMINATION KIT

Crimp & Cleave Termination Kit, tooling & options P/Ns	
Order Number	Description
GBA 1038642	Termination Kit including E-2000™ pliers
GBC 1038284	Fiber cleaver
FBA 1038295	Crimp tool
BCC 1020713	Scissors
GBA 1019341	Cable stripper
BCC 1039756	Fiber stripper
Option pliers for housing assembly	
GBA 1019297	SC plier
GBA 1019413	FC plier
GBA 1019414	ST™ plier

Version 088

SPECIAL

PM (Polarization Maintaining)

PM Mating Adapters Standard P/Ns (New generation)	
Order Number	Description (Type designation, housing/frame colors, fixing type)
E-2000™ Simplex PM mating adapters (PC version) (New generation)	
EBS 1047258	E-2000™ simplex PM mating adapter, blue / blue, without fixation
EBS 1047259	E-2000™ simplex PM mating adapter, blue / blue, screw fixing clip (M2 x 8 mm steel)
EBS 1047260	E-2000™ simplex PM mating adapter, blue / blue, quick fixing clip (A)
EBS 1047261	E-2000™ simplex PM mating adapter, blue / blue, quick fixing clip (B)
EBS 1047262	E-2000™ simplex PM mating adapter, blue / blue, print fixing clip (6 pins)
E-2000™ Simplex PM mating adapters (APC version) (New generation)	
EBS 1047263	E-2000™ simplex PM mating adapter, green / green, without fixation
EBS 1047264	E-2000™ simplex PM mating adapter, green / green, screw fixing clip (M2 x 8 mm steel)
EBS 1047265	E-2000™ simplex PM mating adapter, green / green, quick fixing clip (A)
EBS 1047266	E-2000™ simplex PM mating adapter, green / green, quick fixing clip (B)
EBS 1047267	E-2000™ simplex PM mating adapter, green / green, print fixing clip (6 pins)
E-2000™ PM IP65 simplex mating adapters (PC version) (New generation)	
EBS 1053674	E-2000™ PM IP65 simplex mating adapter, blue / blue, without fixation
EBS 1053675	E-2000™ PM IP65 simplex mating adapter, blue / blue, screw fixing clip (M2 x 8 mm steel)
EBS 1053676	E-2000™ PM IP65 simplex mating adapter, blue / blue, quick fixing clip (A)
EBS 1053677	E-2000™ PM IP65 simplex mating adapter, blue / blue, quick fixing clip (B)
E-2000™ PM IP65 simplex mating adapters (APC version) (New generation)	
EBS 1053678	E-2000™ PM IP65 simplex mating adapter, green / green, without fixation
EBS 1053679	E-2000™ PM IP65 simplex mating adapter, green / green, screw fixing clip (M2 x 8 mm steel)
EBS 1053680	E-2000™ PM IP65 simplex mating adapter, green / green, quick fixing clip (A)
EBS 1053681	E-2000™ PM IP65 simplex mating adapter, green / green, quick fixing clip (B)
Note: every 100 E-2000™ PM IP65 mating adapters, a service adapter (GBC 1019034) for O' Ring mounting will be added	
E-2000™ PM IP65 EtO simplex mating adapters (PC version) (New generation)	
EBS 1063468	E-2000™ PM IP65 EtO simplex mating adapter, blue / blue, without fixation
EBS 1063469	E-2000™ PM IP65 EtO simplex mating adapter, blue / blue, screw fixing clip (M2 x 8 mm steel)
EBS 1063470	E-2000™ PM IP65 EtO simplex mating adapter, blue / blue, quick fixing clip (A)
EBS 1063471	E-2000™ PM IP65 EtO simplex mating adapter, blue / blue, quick fixing clip (B)
E-2000™ PM IP65 EtO simplex mating adapters (APC version) (New generation)	
EBS 1063472	E-2000™ PM IP65 EtO simplex mating adapter, green / green, without fixation
EBS 1063473	E-2000™ PM IP65 EtO simplex mating adapter, green / green, screw fixing clip (M2 x 8 mm steel)
EBS 1063474	E-2000™ PM IP65 EtO simplex mating adapter, green / green, quick fixing clip (A)
EBS 1063475	E-2000™ PM IP65 EtO simplex mating adapter, green / green, quick fixing clip (B)
Note: every 100 E-2000™ PM IP65 EtO mating adapters, a service adapter (GBC 1019034) for O' Ring mounting will be added	
E-2000™ Simplex PM mating adapters fixing clips	
DAF 1012081	Screw fixing clip
DAF 1012082	Quick fixing clip (Type A)
DAF 1012202	Quick fixing clip (Type B)
DAF 1012091	Print fixing clip (6 pins)
F-3000™ Simplex PM mating adapters	
EBS 1080120	F-3000™ simplex PM mating adapter SM PC, blue, without fixation
EBS 1080121	F-3000™ simplex PM mating adapter SM PC, blue, screw fixing clip (M2 x 4 mm steel)
EBS 1080122	F-3000™ simplex PM mating adapter SM PC, blue, quick fixing clip
EBS 1080123	F-3000™ simplex PM mating adapter SM APC, green, without fixation
EBS 1080124	F-3000™ simplex PM mating adapter SM APC, green, screw fixing clip (M2 x 4 mm steel)
EBS 1080125	F-3000™ simplex PM mating adapter SM APC, green, quick fixing clip
F-3000™ Simplex mating adapters fixing clips	
DAF 1012092	Screw fixing clip
DAF 1029136	Quick fixing clip (2 pieces needed)
SC PM mating adapters (PC version)	
EBS 1027541	SC simplex PM mating adapter, blue, screw and clip fixing type (M2 x 8 mm steel)
EBS 1027453	SC simplex PM mating adapter, blue, small clip fixing type
EBS 1027452	SC simplex PM mating adapter, blue, screw-nut fixing type (M2 x 8 mm steel)
SC PM mating adapters (APC version)	
EBS 1027542	SC simplex PM mating adapter, green, screw and clip fixing type (M2 x 8 mm steel)
EBS 1027456	SC simplex PM mating adapter, green, small clip fixing type
EBS 1027455	SC simplex PM mating adapter, green, screw-nut fixing type (M2 x 8 mm steel)
FC PM mating adapters (PC & APC versions)	
EBS 1015586	FC PM mating adapter, square flange (key 2mm)
EBS 1015584	FC PM mating adapter, square flange (key 2.2mm)
EBS 1015587	FC PM mating adapter, hexagonal flange (key 2mm)
EBS 1015585	FC PM mating adapter, hexagonal flange (key 2.2mm)
EBS 1015588	FC PM mating adapter, round flange (key 2mm)
EBS 1026624	FC PM mating adapter, round flange (key 2.2mm)

AVIM PM mating adapters		
EBS	1080129	AVIM PM mating adapter hexagonal flange
EBS	1080130	AVIM PM Mating adapter square flange no O-ring
EBS	1080131	AVIM PM Mating adapter square flange with O-ring
Mini-AVIM PM mating adapters		
EBS	1080112	Mini-AVIM PM mating adapter square flange
LSA (DIN) PM mating adapter (PC & APC versions)		
EBS	1014337	LSA (DIN) PM mating adapter
DMI PM mating adapters (PC & APC version)		
EBS	1016507	DMI PM mating adapter
DAB	1009209	DMI mating adapter clip

Version 086

HT (High Temperature)

HT Mating Adapters Standard P/Ns	
Order Number	Description Type designation
FC Mating adapters (Square flange type)	
EBI 1015581	FC mating adapter MM, key 2.2 mm
EBI 1015556	FC mating adapter SM PC, key 2.2 mm
EBI 1015565	FC mating adapter SM APC, key 2 mm
EBI 1015564	FC mating adapter SM APC, key 2.2 mm
FC Mating adapters (Hexagonal flange type)	
EBI 1015580	FC mating adapter MM, key 2.2 mm
EBI 1015560	FC mating adapter SM PC, key 2.2 mm
EBI 1015570	FC mating adapter SM APC, key 2 mm
EBI 1015561	FC mating adapter SM APC, key 2.2 mm
FC Mating adapters (Round flange type)	
EBI 1015589	FC mating adapter MM, key 2.2 mm
EBI 1015566	FC mating adapter SM PC, key 2.2 mm
EBI 1015571	FC mating adapter SM APC, key 2 mm
EBI 1015555	FC mating adapter SM APC, key 2.2 mm
LSA (DIN) Mating adapters	
EBH 1014328	LSA (DIN) mating adapter
AVIM Mating adapters	
EBH 1028003	AVIM mating adapter hexagonal flange
EBH 1073322	AVIM Mating adapter square flange no O-ring
P/N for tools and instruction see AVIM P/N list	
Mini-AVIM Mating adapters	
EBN 1058232	Mini-AVIM mating adapter square flange
P/N for tools and instruction see Mini-AVIM P/N list	
DMI Mating adapters	
EBN 1027427	DMI mating adapter MM PC, black caps
EBN 1019156	DMI mating adapter SM PC, blue caps
EBN 1016506	DMI mating adapter SM APC, green caps
DAB 1009209	DMI mating adapter clip
EZ 1063581	DMI mounting set for clip (Screw M2 x 5mm A4 INOX ISO7380; Nut DIN934 INOX)
P/N for tools and instruction see DMI P/N list	

Version 0916

PSm (Power Solution Multi mode)

PSm Mating Adapters Standard P/Ns	
Order Number	Description Type designation

Psm Mating adapters	
EB3 1080910	E-2000™ PSm Mating adapter (Bottom basement)
EB3 1080909	E-2000™ PSm Mating adapter (Bottom basement for PCB)
EB3 1081031	DMI PSm Mating adapter

Version 0317

ALBERINO-PATCH

Alberino standard assembly P/Ne		
Order Number	Description (Type designation, assembly length)	Cable
ENF 1034392	Alberino SM PC/PC standard assembly, 3 m	9/125/1.6 mm, yellow
ENF 1034393	Alberino SM PC/PC standard assembly, 3 m	9/125/2.1 mm, yellow
ENF 1034394	Alberino SM PC/PC standard assembly, 3 m	9/125/2.4 mm, yellow
ENF 1034395	Alberino SM PC/PC standard assembly, 3 m	9/125/3.0 mm, yellow
ENF 1034396	Alberino SM PC/PC standard assembly, 5 m	9/125/1.6 mm, yellow
ENF 1034397	Alberino SM PC/PC standard assembly, 5 m	9/125/2.1 mm, yellow
ENF 1034398	Alberino SM PC/PC standard assembly, 5 m	9/125/2.4 mm, yellow
ENF 1034399	Alberino SM PC/PC standard assembly, 5 m	9/125/3.0 mm, yellow
ENF 1034400	Alberino SM PC/PC standard assembly, 10 m	9/125/1.6 mm, yellow
ENF 1034401	Alberino SM PC/PC standard assembly, 10 m	9/125/2.1 mm, yellow
ENF 1034402	Alberino SM PC/PC standard assembly, 10 m	9/125/2.4 mm, yellow
ENF 1034403	Alberino SM PC/PC standard assembly, 10 m	9/125/3.0 mm, yellow
ENF 1034404	Alberino SM PC/APC standard assembly, 3 m	9/125/1.6 mm, yellow
ENF 1034405	Alberino SM PC/APC standard assembly, 3 m	9/125/2.1 mm, yellow
ENF 1034406	Alberino SM PC/APC standard assembly, 3 m	9/125/2.4 mm, yellow
ENF 1034414	Alberino SM PC/APC standard assembly, 3 m	9/125/3.0 mm, yellow
ENF 1034415	Alberino SM PC/APC standard assembly, 5 m	9/125/1.6 mm, yellow
ENF 1034416	Alberino SM PC/APC standard assembly, 5 m	9/125/2.1 mm, yellow
ENF 1034417	Alberino SM PC/APC standard assembly, 5 m	9/125/2.4 mm, yellow
ENF 1034418	Alberino SM PC/APC standard assembly, 5 m	9/125/3.0 mm, yellow
ENF 1034419	Alberino SM PC/APC standard assembly, 10 m	9/125/1.6 mm, yellow
ENF 1034420	Alberino SM PC/APC standard assembly, 10 m	9/125/2.1 mm, yellow
ENF 1034421	Alberino SM PC/APC standard assembly, 10 m	9/125/2.4 mm, yellow
ENF 1034422	Alberino SM PC/APC standard assembly, 10 m	9/125/3.0 mm, yellow
ENF 1034423	Alberino SM APC/APC standard assembly, 3 m	9/125/1.6 mm, yellow
ENF 1034424	Alberino SM APC/APC standard assembly, 3 m	9/125/2.1 mm, yellow
ENF 1034425	Alberino SM APC/APC standard assembly, 3 m	9/125/2.4 mm, yellow
ENF 1034426	Alberino SM APC/APC standard assembly, 3 m	9/125/3.0 mm, yellow
ENF 1034427	Alberino SM APC/APC standard assembly, 5 m	9/125/1.6 mm, yellow
ENF 1034433	Alberino SM APC/APC standard assembly, 5 m	9/125/2.1 mm, yellow
ENF 1034434	Alberino SM APC/APC standard assembly, 5 m	9/125/2.4 mm, yellow
ENF 1034435	Alberino SM APC/APC standard assembly, 5 m	9/125/3.0 mm, yellow
ENF 1034436	Alberino SM APC/APC standard assembly, 10 m	9/125/1.6 mm, yellow
ENF 1034437	Alberino SM APC/APC standard assembly, 10 m	9/125/2.1 mm, yellow
ENF 1034438	Alberino SM APC/APC standard assembly, 10 m	9/125/2.4 mm, yellow
ENF 1034439	Alberino SM APC/APC standard assembly, 10 m	9/125/3.0 mm, yellow

Notes: For other configurations, please refer to the Order information of the Alberino solution datasheet.
1.6, 2.1, and 2.4mm cables are LSOH; 3.0mm is OFNR.

Connector Housing & Plier P/Ne	
Order Number	Description
Housing types (Type designation, housing color)	
DBA 1026408	E-2000™ MM PC with cap, beige
DBA 1031687	E-2000™ SM PC with cap, blue
DBA 1031688	E-2000™ SM APC with cap, green
DBA 1026428	SC MM PC with cap, beige
DBA 1008734	SC SM PC with cap, blue
DBA 1008735	SC SM APC with cap, green
DBA 1031683	FC PC (key 2.14mm) with cap, black
DBA 1031684	FC APC (key 2.14mm) with cap, black
DBA 1031686	FC APC (key 2mm) with cap, red
DBA 1031695	ST™ PC with cap, black
DBA 1026429	SC MM PC without cap, beige
DBA 1035410	SC SM PC without cap, blue
DBA 1035472	SC SM APC without cap, green
DBA 1031682	FC PC (key 2.14mm) without cap, black
DBA 1035473	FC APC (key 2.14mm) without cap, black
DBA 1035474	FC APC (key 2mm) without cap, red
DBA 1031696	ST™ PC without cap, black
Tools for housing assembly	
GBA 1028799	Mounting pliers for PC and APC bodies (without adapters)
FBD 1028792	Adapter E-2000™ PC/APC for mounting pliers
FBD 1028788	Adapter SC PC/APC for mounting pliers
FBD 1028790	Adapter FC PC/APC for mounting pliers
FBD 1028791	Adapter ST PC for mounting pliers

OUTDOOR/INDUSTRIAL

revos E-2000 Bulkhead Standard P/Ns	
Order Number	Description (Type designation, internal adapter colors)
EBT 1072415	revos E-2000 bulkhead 2 x MM, beige
EBT 1072414	revos E-2000 bulkhead 2 x SM PC, blue
EBT 10720475	revos E-2000 bulkhead 2 x SM APC, green

Version 015

OUTDOOR/INDUSTRIAL

E-2000™ RHA Female Panel Adapters Standard P/Ns	
Order Number	Description (Type designation, internal adapter colors)
EBA 1027596	E-2000™ RHA female panel adapter 2 x MM, beige
EBA 1027597	E-2000™ RHA female panel adapter 2 x SM PC, blue
EBA 1027598	E-2000™ RHA female panel adapter 2 x SM APC, green
EBA 1027599	E-2000™ RHA female panel adapter 4 x MM, beige
EBA 1021717	E-2000™ RHA female panel adapter 4 x SM PC, blue
EBA 1021718	E-2000™ RHA female panel adapter 4 x SM APC, green

Version 015

OUTDOOR/INDUSTRIAL

F-3000™ ODVA Bulkhead Standard P/Ns	
Order Number	Description (Type designation, internal adapter colors)
EBT 1066534	F-3000™ ODVA bulkhead 2 x MM, beige
EBT 1066533	F-3000™ ODVA bulkhead 2 x SM PC, blue
EBT 1066522	F-3000™ ODVA bulkhead 2 x SM APC, green

Version 112

OUTDOOR/INDUSTRIAL

OD3 Bulkhead Standard P/Ns	
Order Number	Description (Type designation, internal adapter colors)
EBT 1069486	OD3 bulkhead 2 x MM, beige
EBT 1069485	OD3 bulkhead 2 x SM PC, blue
EBT 1069483	OD3 bulkhead 2 x SM APC, green

Version 013

OUTDOOR/INDUSTRIAL

MIL-38999 connector housing sets (Including DM Insert)

Order number	Description
Upon request	Type 1 connector set for 5 mm cable
Upon request	Type 1 connector set for 5,5 mm cable
Upon request	Type 2 connector set
Upon request	Type 3 connector set
Upon request	Type 4 connector set
Upon request	Type 5 Bulkhead set
Upon request	Type 6 Bulkhead set

Alberini Fusionset MM 50µm for field assembly

Suitable connector type

Order number	Description	
DCC 1075830	Alberino Fusion set for fiber (without boot)	1,2
DCC 1075843	Alberino Fusion set for fiber (with boot)	4,6
DCC 1075849	Alberino Fusion set for cable <2mm (600um fiber)	4,6
DCC 1075850	Alberino Fusion set for cable <2mm (900um fiber)	4,6
DCC 1075851	Alberino Fusion set for cable 2-3mm (600um fiber)	3,4,5,6
DCC 1075852	Alberino Fusion set for cable 2-3mm (900um fiber)	3,4,5,6

Alberini Fusionset MM 62.5µm for field assembly

Suitable connector type

Order number	Description	
DCC 1070220	Alberino Fusion set for fiber (without boot)	1,2
DCC 1075844	Alberino Fusion set for fiber (with boot)	4,6
DCC 1075854	Alberino Fusion set for cable <2mm (600um fiber)	4,6
DCC 1075855	Alberino Fusion set for cable <2mm (900um fiber)	4,6
DCC 1075856	Alberino Fusion set for cable 2-3mm (600um fiber)	3,4,5,6
DCC 1075857	Alberino Fusion set for cable 2-3mm (900um fiber)	3,4,5,6

Alberini Fusion sets (SM PC) for field assembly





Suitable connector type





Order number	Description	
DCC 1074826	Alberino Fusion set for fiber (without boot)	1,2
DCC 1075845	Alberino Fusion set for fiber (with boot)	4,6
DCC 1075860	Alberino Fusion set for cable <2mm (600um fiber)	4,6
DCC 1075861	Alberino Fusion set for cable <2mm (900um fiber)	4,6
DCC 1075862	Alberino Fusion set for cable 2-3mm (600um fiber)	3,4,5,6
DCC 1075863	Alberino Fusion set for cable 2-3mm (900um fiber)	3,4,5,6

Alberini Fusion sets (SM APC) for field assembly

Suitable connector type

Order number	Description	
DCC 1074827	Alberino Fusion set for fiber (without boot)	1,2
DCC 1075846	Alberino Fusion set for fiber (with boot)	4,6
DCC 1075864	Alberino Fusion set for cable <2mm (600um fiber)	4,6
DCC 1075865	Alberino Fusion set for cable <2mm (900um fiber)	4,6
DCC 1075866	Alberino Fusion set for cable 2-3mm (600um fiber)	3,4,5,6
DCC 1075867	Alberino Fusion set for cable 2-3mm (900um fiber)	3,4,5,6

Other configuration components & spare parts			Suitable connector type
Order number	Description		
EZ 1075868	Male Electrical termini set (including hollow pin + sleeve)	1,2,3,4,5,6	
EZ 1075869	Female Electrical termini set	1,2,3,4,5,6	
DBZ 1073767	Hollow pin + sleeve	1,2,3,4,5,6	
DBZ 1073781	Termini shell	1,2,3,4,5,6	
DAC 1073782	DM insert	1,2,3,4,5,6	
BEE 1074907	Metal cap for connector	1,2,3,4	
BEE 1074906	Metal cap for bulkhead	5,6	
BEE 1074903	Optional bulkhead gasket (Fluorosilicone, thickness 0.8mm)	5,6	

Tools			Suitable connector type
Order number	Description		
GF 1074654	Termini extractor	Connector & Bulkhead	
GF 1074651	Alberino extractor	Connector & Bulkhead	
GF 1074680	Termini assembler	Connector & Bulkhead	
GF 1074744	Hollow pin tool	Connector & Bulkhead	

Version 1215

OUTDOOR/INDUSTRIAL

HE-2000 connector housing sets (Including DM Insert)

Order number	Description
EAT 1078051	Connector housing set for 5,5 mm cable (Type 1)
EBT 1078052	Bulkhead housing set (Type 2), gasket included

Alberini Fusionset MM 50µm for field assembly

Suitable connector type

Order number	Description	
DCC 1075830	Alberino Fusion set for fiber (without boot)	Connector
DCC 1075843	Alberino Fusion set for fiber (with boot)	Bulkhead
DCC 1075849	Alberino Fusion set for cable <2mm (600um fiber)	Bulkhead
DCC 1075850	Alberino Fusion set for cable <2mm (900um fiber)	Bulkhead
DCC 1075851	Alberino Fusion set for cable 2-3mm (600um fiber)	Bulkhead
DCC 1075852	Alberino Fusion set for cable 2-3mm (900um fiber)	Bulkhead

Alberini Fusionset MM 62.5µm for field assembly

Suitable connector type

Order number	Description	
DCC 1070220	Alberino Fusion set for fiber (without boot)	Connector
DCC 1075844	Alberino Fusion set for fiber (with boot)	Bulkhead
DCC 1075854	Alberino Fusion set for cable <2mm (600um fiber)	Bulkhead
DCC 1075855	Alberino Fusion set for cable <2mm (900um fiber)	Bulkhead
DCC 1075856	Alberino Fusion set for cable 2-3mm (600um fiber)	Bulkhead
DCC 1075857	Alberino Fusion set for cable 2-3mm (900um fiber)	Bulkhead

Alberini Fusion sets (SM PC) for field assembly







Suitable connector type





Order number	Description	
DCC 1074826	Alberino Fusion set for fiber (without boot)	Connector
DCC 1075845	Alberino Fusion set for fiber (with boot)	Bulkhead
DCC 1075860	Alberino Fusion set for cable <2mm (600um fiber)	Bulkhead
DCC 1075861	Alberino Fusion set for cable <2mm (900um fiber)	Bulkhead
DCC 1075862	Alberino Fusion set for cable 2-3mm (600um fiber)	Bulkhead
DCC 1075863	Alberino Fusion set for cable 2-3mm (900um fiber)	Bulkhead

Alberini Fusion sets (SM APC) for field assembly

Suitable connector type

Order number	Description	
DCC 1074827	Alberino Fusion set for fiber (without boot)	Connector
DCC 1075846	Alberino Fusion set for fiber (with boot)	Bulkhead
DCC 1075864	Alberino Fusion set for cable <2mm (600um fiber)	Bulkhead
DCC 1075865	Alberino Fusion set for cable <2mm (900um fiber)	Bulkhead
DCC 1075866	Alberino Fusion set for cable 2-3mm (600um fiber)	Bulkhead
DCC 1075867	Alberino Fusion set for cable 2-3mm (900um fiber)	Bulkhead

Other configuration components & spare parts			Suitable connector type
Order number	Description		
EZ 1075868	Male Electrical termini set (including hollow pin + sleeve)	Connector & Bulkhead	
EZ 1075869	Female Electrical termini set	Connector & Bulkhead	
DBZ 1073767	Hollow pin + sleeve	Connector & Bulkhead	
DBZ 1073781	Termini shell	Connector & Bulkhead	
DAE 1073782	DM insert	Connector & Bulkhead	
BEE 1075788	Gasket (thickness: 1mm)	Bulkhead	
DBT 1078020	Connector protection cap	Connector	

Tools			Suitable connector type
Order number	Description		
GF 1074654	Termini extractor	Connector & Bulkhead	
GF 1074651	Alberino extractor	Connector & Bulkhead	
GF 1074680	Termini assembler	Connector & Bulkhead	
GF 1074744	Hollow pin tool	Connector & Bulkhead	

Version 1115

ATTENUATORS

OAF E-2000™	
Order Number	Description (Type designation, attenuation value, latch & housing colors)
OAF E-2000™ PC SM	
EGA 1034443	OAF E-2000™ PC SM, (2 dB), blue
EGA 1034444	OAF E-2000™ PC SM, (4 dB), blue
EGA 1034445	OAF E-2000™ PC SM, (5 dB), blue
EGA 1034446	OAF E-2000™ PC SM, (6 dB), blue
EGA 1034447	OAF E-2000™ PC SM, (10 dB), blue
EGA 1034448	OAF E-2000™ PC SM, (15 dB), blue
EGA 1034449	OAF E-2000™ PC SM, (20 dB), blue
EGA 1034450	OAF E-2000™ PC SM, (25 dB), blue
EGA 1034451	OAF E-2000™ PC SM, (30 dB), blue
OAF E-2000™ APC SM	
EGA 1034452	OAF E-2000™ APC SM, (2 dB), green
EGA 1034453	OAF E-2000™ APC SM, (4 dB), green
EGA 1034454	OAF E-2000™ APC SM, (5 dB), green
EGA 1034456	OAF E-2000™ APC SM, (6 dB), green
EGA 1034457	OAF E-2000™ APC SM, (10 dB), green
EGA 1034459	OAF E-2000™ APC SM, (15 dB), green
EGA 1034460	OAF E-2000™ APC SM, (20 dB), green
EGA 1034461	OAF E-2000™ APC SM, (25 dB), green
EGA 1034463	OAF E-2000™ APC SM, (30 dB), green
Cleaning tools	
GBC 1019034	Service Adapter
GBA 1019356	Handling tool
GBB 1019343	Cleaning set

Other latch colors upon request.

Version 036

ATTENUATORS

OAF F-3000™	
Order Number	Description (Type designation, attenuation value, housing color)
OAF F-3000™ PC SM	
EGB 1021467	OAF F-3000™ PC SM, (2 dB), blue
EGB 1024483	OAF F-3000™ PC SM, (4 dB), blue
EGB 1018951	OAF F-3000™ PC SM, (5 dB), blue
EGB 1022397	OAF F-3000™ PC SM, (6 dB), blue
EGB 1018952	OAF F-3000™ PC SM, (10 dB), blue
EGB 1018953	OAF F-3000™ PC SM, (15 dB), blue
EGB 1019012	OAF F-3000™ PC SM, (20 dB), blue
EGB 1026855	OAF F-3000™ PC SM, (25 dB), blue
EGB 1026856	OAF F-3000™ PC SM, (30 dB), blue
OAF F-3000™ APC SM	
EGB 1026857	OAF F-3000™ APC SM, (2 dB), green
EGB 1026858	OAF F-3000™ APC SM, (4 dB), green
EGB 1026859	OAF F-3000™ APC SM, (5 dB), green
EGB 1026860	OAF F-3000™ APC SM, (6 dB), green
EGB 1025494	OAF F-3000™ APC SM, (10 dB), green
EGB 1026861	OAF F-3000™ APC SM, (15 dB), green
EGB 1026862	OAF F-3000™ APC SM, (20 dB), green
EGB 1026863	OAF F-3000™ APC SM, (25 dB), green
EGB 1026864	OAF F-3000™ APC SM, (30 dB), green
Cleaning tools	
GBC 1019483	Service Adapter
GBC 1022279	Handling tool
DBA 1028145	Ferrule release tool

Version 015

ATTENUATORS

OAF SC	
Order Number	Description (Type designation, attenuation value, housing color)
OAF SC PC SM	
EGC 1034472	OAF SC PC SM, (2 dB), blue
EGC 1034473	OAF SC PC SM, (4 dB), blue
EGC 1034474	OAF SC PC SM, (5 dB), blue
EGC 1034475	OAF SC PC SM, (6 dB), blue
EGC 1034476	OAF SC PC SM, (10 dB), blue
EGC 1034477	OAF SC PC SM, (15 dB), blue
EGC 1034478	OAF SC PC SM, (20 dB), blue
EGC 1034479	OAF SC PC SM, (25 dB), blue
EGC 1034480	OAF SC PC SM, (30 dB), blue
OAF SC APC SM	
EGC 1034481	OAF SC APC SM, (2 dB), green
EGC 1034482	OAF SC APC SM, (4 dB), green
EGC 1034483	OAF SC APC SM, (5 dB), green
EGC 1034484	OAF SC APC SM, (6 dB), green
EGC 1034485	OAF SC APC SM, (10 dB), green
EGC 1034486	OAF SC APC SM, (15 dB), green
EGC 1034487	OAF SC APC SM, (20 dB), green
EGC 1034488	OAF SC APC SM, (25 dB), green
EGC 1034489	OAF SC APC SM, (30 dB), green

Version 036

ATTENUATORS

OAF FC	
Order Number	Description (Type designation, attenuation value)
OAF FC PC SM key 2.2 mm	
EGI 1034490	OAF FC PC SM key 2.2 mm, (2 dB)
EGI 1034491	OAF FC PC SM key 2.2 mm, (4 dB)
EGI 1034492	OAF FC PC SM key 2.2 mm, (5 dB)
EGI 1034493	OAF FC PC SM key 2.2 mm, (6 dB)
EGI 1034494	OAF FC PC SM key 2.2 mm, (10 dB)
EGI 1034495	OAF FC PC SM key 2.2 mm, (15 dB)
EGI 1034496	OAF FC PC SM key 2.2 mm, (20 dB)
EGI 1034497	OAF FC PC SM key 2.2 mm, (25 dB)
EGI 1034498	OAF FC PC SM key 2.2 mm, (30 dB)
OAF FC APC SM key 2.2 mm	
EGI 1034499	OAF FC APC SM key 2.2 mm, (2 dB)
EGI 1034500	OAF FC APC SM key 2.2 mm, (4 dB)
EGI 1034501	OAF FC APC SM key 2.2 mm, (5 dB)
EGI 1034502	OAF FC APC SM key 2.2 mm, (6 dB)
EGI 1034503	OAF FC APC SM key 2.2 mm, (10 dB)
EGI 1034504	OAF FC APC SM key 2.2 mm, (15 dB)
EGI 1034505	OAF FC APC SM key 2.2 mm, (20 dB)
EGI 1034506	OAF FC APC SM key 2.2 mm, (25 dB)
EGI 1034507	OAF FC APC SM key 2.2 mm, (30 dB)
OAF FC APC SM key 2 mm	
EGI 1034508	OAF FC APC SM key 2 mm, (2 dB)
EGI 1034509	OAF FC APC SM key 2 mm, (4 dB)
EGI 1034510	OAF FC APC SM key 2 mm, (5 dB)
EGI 1034511	OAF FC APC SM key 2 mm, (6 dB)
EGI 1034521	OAF FC APC SM key 2 mm, (10 dB)
EGI 1034522	OAF FC APC SM key 2 mm, (15 dB)
EGI 1034523	OAF FC APC SM key 2 mm, (20 dB)
EGI 1034524	OAF FC APC SM key 2 mm, (25 dB)
EGI 1034525	OAF FC APC SM key 2 mm, (30 dB)

Version 036

ATTENUATORS

OAF LSA (DIN)	
Order Number	Description (Type designation, attenuation value)

OAF LSA (DIN) PC SM	
EGH 1034526	OAF LSA (DIN) PC SM, (5 dB) Version 062
EGH 1034527	OAF LSA (DIN) PC SM, (10 dB)
EGH 1034528	OAF LSA (DIN) PC SM, (15 dB)
EGH 1034529	OAF LSA (DIN) PC SM, (20 dB)
EGH 1034530	OAF LSA (DIN) PC SM, (25 dB)
EGH 1034531	OAF LSA (DIN) PC SM, (30 dB)

Version 036

ATTENUATORS

OAF & OAS ST™	
Order Number	Description (Type designation, attenuation value)
OAF ST™ PC SM	
EGK 1018592	OAF ST™ PC SM, (5 dB)
EGK 1018500	OAF ST™ PC SM, (10 dB)
EGK 1018594	OAF ST™ PC SM, (15 dB)
EGK 1018501	OAF ST™ PC SM, (20 dB)
EGK 1018502	OAF ST™ PC SM, (25 dB)
EGK 1018503	OAF ST™ PC SM, (30 dB)
OAS ST™ PC MM, 850 nm	
EFK 1018684	OAS ST™ PC MM 850 nm, (5 dB)
EFK 1018504	OAS ST™ PC MM 850 nm, (10 dB)
EFK 1027428	OAS ST™ PC MM 850 nm, (15 dB)
OAS ST™ PC MM, 1310 nm	
EFK 1018655	OAS ST™ PC MM 1310 nm, (5 dB)
EFK 1018505	OAS ST™ PC MM 1310 nm, (10 dB)
EFK 1019032	OAS ST™ PC MM 1310 nm, (15 dB)

Version 015

ATTENUATORS

OAF DIAMOND	
Order Number	Description (Type designation, attenuation value)
OAF DIAMOND PC SM	
EGL 1026825	OAF DIAMOND PC SM, (5 dB)
EGL 1026901	OAF DIAMOND PC SM, (10 dB)
EGL 1026902	OAF DIAMOND PC SM, (15 dB)
EGL 1026903	OAF DIAMOND PC SM, (20 dB)
EGL 1026904	OAF DIAMOND PC SM, (25 dB)
EGL 1026905	OAF DIAMOND PC SM, (30 dB)

Version 015

HYBRID MATING ADAPTERS

Standard Hybrid Mating Adapters	
Order Number	Description (Type designation, plastic color)
ECH 1018449	HYB. LSA (DIN) / FC (key 2.2 mm)
ECI 1018466	HYB. FC (key 2.2 mm) / LSA (DIN)
ECH 1018448	HYB. LSA (DIN) / ST
ECK 1018496	HYB. ST TM / LSA-LSG (DIN)
ECC 1026865	HYB. LSA (DIN) / SC MM PC, beige
ECC 1018489	HYB. LSA (DIN) / SC SM PC, blue
ECC 1018490	HYB. LSA (DIN) / SC SM APC, green
ECC 1026866	HYB. SC / ST TM MM PC, beige
ECC 1018492	HYB. SC / ST TM SM PC, blue
ECI 1027433	HYB. FC (key 2.2 mm) / SC Square MM PC, beige
ECI 1018462	HYB. FC (key 2.2 mm) / SC Square SM PC, blue
ECI 1018464	HYB. FC (key 2.2 mm) / SC Square SM APC, green
ECI 1018463	HYB. FC (key 2 mm) / SC Square SM APC, green
ECC 1027434	HYB. SC / FC (key 2.2 mm) MM PC, beige
ECC 1018487	HYB. SC / FC (key 2.2 mm) SM PC, blue
ECC 1018488	HYB. SC / FC (key 2.2 mm) SM APC, green
ECC 1018491	HYB. SC / FC (key 2 mm) SM APC, green
ECI 1018465	HYB. FC (key 2.2 mm) / ST Square
ECK 1018497	HYB. ST TM / FC (key 2.2 mm)
ECC 1027435	HYB. SC / ST TM Duplex MM PC, beige
ECC 1018486	HYB. SC / ST TM Duplex SM PC, blue

Version 015

HYBRID MATING ADAPTERS

E-2000™ Hybrid Mating Adapters	
Order Number	Description (Type designation, plastic housing color)
ECH 1027436	HYB. E-2000™ / LSA (DIN) MM PC, beige
ECH 1018921	HYB. E-2000™ / LSA (DIN) SM PC, blue
ECH 1018934	HYB. E-2000™ / LSA (DIN) SM APC, green
ECA 1027437	HYB. E-2000™ / FC MM PC (dimension b 2.2mm), beige
ECA 1018963	HYB. E-2000™ / FC SM PC (dimension b 2.2mm), blue
ECA 1018964	HYB. E-2000™ / FC SM APC (dimension b 2.2mm), green
ECA 1018962	HYB. E-2000™ / FC SM APC (dimension b 2 mm), green
ECA 1027438	HYB. E-2000™ / SC MM PC, beige
ECA 1018610	HYB. E-2000™ / SC SM PC, blue
ECA 1018609	HYB. E-2000™ / SC SM APC, green
ECA 1027439	HYB. E-2000™ / ST™ MM PC, beige
ECA 1018922	HYB. E-2000™ / ST™ SM PC, blue

Other frame colors or frames with mechanical keying upon request

Version 015

HYBRID MATING ADAPTERS

F-3000™ Hybrid Mating Adapters	
Order Number	Description (Type designation, plastic housing color)
ECB 1027441	HYB. F-3000™/LSA (DIN) MM PC, beige
ECB 1018853	HYB. F-3000™/LSA (DIN) SM PC, blue
ECB 1018818	HYB. F-3000™/LSA (DIN) SM APC, green
ECB 1027442	HYB. F-3000™/FC MM PC (dimension b 2.2mm), beige
ECB 1018819	HYB. F-3000™/FC SM PC (dimension b 2.2mm), blue
ECB 1018899	HYB. F-3000™/FC SM APC (dimension b 2.2mm), green
ECB 1027450	HYB. F-3000™/FC SM APC (dimension b 2 mm), green
ECB 1027443	HYB. F-3000™/SC MM PC, beige
ECB 1018843	HYB. F-3000™/SC SM PC, blue
ECB 1018900	HYB. F-3000™/SC SM APC, green
ECB 1027445*	HYB. F-3000™/LSH (E-2000™) MM PC, beige
ECB 1018842*	HYB. F-3000™/LSH (E-2000™) SM PC, blue
ECB 1016467*	HYB. F-3000™/LSH (E-2000™) SM APC, green

* Other frame colors or frames with mechanical keying upon request

Version 015

UGT and SI Optical Transition Adapters

UGT and SI Optical Transition Adapters	
Order Number	Description (Type designation, housing type & color)
EEA 1051675*	UGT E-2000™ APC/PC SM, plastic blue for PC and green for APC side
EEA 1051676*	UGT E-2000™ PC/APC SM, plastic blue for PC and green for APC side
EEA 1062721*	SI E-2000™ APC/APC SM, plastic green for both sides
EEA 1064955*	SI E-2000™ PC/PC SM, plastic blue for both sides
EEA 1064959*	SI E-2000™ PC/PC MM, plastic beige for both sides, with MM 0°/0° 50µm marking
EEA 1064965*	SI E-2000™ PC/PC MM, plastic beige for both sides, with MM 0°/0° 62,5µm marking
EEB 1064969	UGT F-3000™ APC/PC SM, plastic black with 8°/0° marking
EEB 1064970	UGT F-3000™ PC/APC SM, plastic black with 0°/8° marking
EEB 1064971	SI F-3000™ APC/APC SM, plastic black with 8°/8° marking
EEB 1064972	SI F-3000™ PC/PC SM, plastic black with 0°/0° marking
EEB 1064973	SI F-3000™ PC/PC MM, plastic beige with MM 0°/0° 50µm marking
EEB 1064974	SI F-3000™ PC/PC MM, plastic beige with MM 0°/0° 62,5µm marking
EEC 1034863	UGT SC APC/PC SM, plastic black with 8°/0° marking
EEC 1034864	UGT SC PC/APC SM, plastic black with 0°/8° marking
EEC 1064976	SI SC APC/APC SM, plastic black with 8°/8° marking
EEC 1064977	SI SC PC/PC SM, plastic black with 0°/0° marking
EEC 1064978	SI SC PC/PC MM, plastic beige with MM 0°/0° 50µm marking
EEC 1064979	SI SC PC/PC MM, plastic beige with MM 0°/0° 62,5µm marking
EEL 1034865**	UGT FC APC/PC SM, metal with SM 8°/0° marking, Key 2.2mm
EEL 1034866**	UGT FC PC/APC SM, metal with SM 0°/8° marking, Key 2.2mm
EEL 1064421**	SI FC APC/APC SM, metal with SM 8°/8° marking, Key 2.2mm
EEL 1061863**	SI FC PC/PC SM, metal with SM 0°/0° marking, Key 2.2mm
EEL 1064980**	SI FC PC/PC MM, metal with MM 0°/0° 50µm marking, Key 2.2mm
EEL 1064981**	SI FC PC/PC MM, metal with MM 0°/0° 62,5µm marking, Key 2.2mm
EEL 1064982	SI ST PC/PC SM, metal with SM 0°/0° marking
EEL 1064983	SI ST PC/PC MM, metal with MM 0°/0° 50µm marking
EEL 1064984	SI ST PC/PC MM, metal with MM 0°/0° 62,5µm marking
EED 1075349	UGT DiaLink PC/APC SM, plastic beige with SM 0°/8° marking
EED 1075350	UGT DiaLink APC/PC SM, plastic beige with SM 8°/0° marking
EED 1075351	SI DiaLink PC/PC SM, plastic beige with SM 0°/0° marking
EED 1075352	SI DiaLink APC/APC SM, plastic beige with SM 8°/8° marking
EED 1075353	SI DiaLink PC/PC MM, plastic beige with MM 0°/0° 50µm marking
EED 1075354	SI DiaLink PC/PC MM, plastic beige with MM 0°/0° 62,5µm marking

* Other latch or frame colors upon request. (latch + frame of same color)

** Key 2mm upon request

Version 0416

Optical Termination Modules (OTM)

Optical Termination Modules (OTM)	
Order Number	Description (Type designation, housing color)
EL 1034867*	OTM E-2000™ PC, blue housing and latch
EL 1034868*	OTM E-2000™ APC, green housing and latch
EL 1034869	OTM SC PC, blue
EL 1034870	OTM SC APC, green
EL 1034871	OTM FC PC, gray
EL 1034872	OTM FC APC, gray
EL 1016351	OTM F-3000™ PC, blue housing and latch
EL 1016352	OTM F-3000™ APC, green housing and latch

* Other latch colors or latches with mechanical keying upon request

Optical Gold Reflectors (OGR)

Optical Gold Reflectors (OGR)	
Order Number	Description (Type designation, housing color)
ELC 1074037	OGR E-2000™ PC, blue housing and latch*
ELC 1074039	OGR SC PC, blue
ELC 1074040	OGR FC PC, gray
ELC 1074042	OGR ST™ PC, black
ELC 1074043	OGR F-3000™ (LC) PC, blue
ELC 1074046	OGR E-2000™ APC, green housing and latch *
ELC 1074047	OGR SC APC, green
ELC 1074048	OGR FC APC, gray
ELC 1074049	OGR ST™ APC, black
ELC 1074050	OGR F-3000™ (LC) APC, green

* Other colour codes or mechanical keys upon request

Version 015

Multipurpose Adapter System (MAS)

Multipurpose Adapter System (MAS)	
Order Number	Description (Type designation)
EDF 1022898	MAS Universal Flange FC (key 2.2 mm) interface (M2 x 5 mm steel)
EOX 1059841	MAS Universal Flange Mini-AVIM interface (M2 x 5 mm steel)
EDF 1023701	MAS E-2000™
EDF 1023681	MAS SC
EDF 1023676	MAS DIN
EDF 1018981	MAS ST™
EDF 1023682	MAS LC (F-3000™)
EDF 1023677	MAS FC (Key ø 2.2 mm)
EDF 1023678	MAS FC (Key ø 2 mm)

Version 0714

ADT-UNI (Universal adapter interface)

Universal Adapter Interface (ADT-UNI)	
Order Number	Description (Type designation, plastic housing color)
EDB 1018648*	ADT-UNI E-2000™, green housing and frame
EDB 1018520	ADT-UNI DIN
EDB 1018521	ADT-UNI FC (Key ø 2.2 mm)
EDB 1018526	ADT-UNI FC (Key ø 2 mm)
EDB 1018525	ADT-UNI SC, beige
EDB 1018522	ADT-UNI ST™

* Other housing and frame colors or frames with mechanical keying upon request

Version 015

Interface Module (IMOD)

Interface Module (IMOD)	
Order Number	Description (Type designation, plastic housing color)
EJB 1031503*	IMOD E-2000™ PC blue
EJB 1080455*	IMOD E-2000™ APC green
EJB 1029887	IMOD F-3000™ PC blue
EJB 1018494	IMOD SC PC blue
EJB 1018460	IMOD LSA (DIN) PC Square flange
EJB 1027379	IMOD LSA (DIN) PC Round (with ferrule stop)
EJB 1018546	IMOD LSA (DIN) PC Round (without ferrule stop)
EJB 1025806	IMOD FC PC Square flange (Key 2.2 mm)
EJB 1018619	IMOD FC PC JDS Square flange (Key 2 mm)
EJB 1031501	IMOD FC APC Square flange (Key 2.2 mm)
EJB 1018911	IMOD FC PC Round (Key 2.2 mm)
EJB 1018866	IMOD ST PC (with screw nut)
EJB 1062148	IMOD Mini-AVIM PC Square flange
EJB 1066853	IMOD Mini-AVIM APC Square flange
EJB 1077637	IMOD F-SMA

* Other frame colors upon request.

Version 1106

FIELD TERMINATION

ZEUS D50 (Fusion Field Termination Kits)	
Order Number	Description
GY 1056251	ZEUS D50 with F-3000™ 600 Kit
GY 1056250	ZEUS D50 with F-3000™ 900 Kit
GY 1057035	ZEUS D50 with SC 900 Kit
GY 1059756	ZEUS D50 with E-2000™ 900 Kit
GY 1063903	ZEUS D50 with FC 900 Kit
GY 1063902	ZEUS D50 with ST 900 Kit

Note: For spare parts and accessories, please contact your local Diamond representative.

E-2000™ FUSION

E-2000™ Fusion Connector Sets Standard (with BI-adhesive alberlno) P/Ns		
Order Number	Description (Type designation, housing/straight boot colors, fiber type)	Fibre/Cable
E-2000™ Fusion Simplex		
EAA 1057246	E-2000™ Fusion simplex MM PC, beige / black, 50 µm	600 µm
EAA 1057247	E-2000™ Fusion simplex MM PC, beige / black, 50 µm	900 µm
EAA 1057248	E-2000™ Fusion simplex MM PC, beige / black, 50 µm	1.6 mm
EAA 1057249	E-2000™ Fusion simplex MM PC, beige / black, 50 µm	2.1 mm
EAA 1057250	E-2000™ Fusion simplex MM PC, beige / black, 50 µm	2.4 mm
EAA 1057251	E-2000™ Fusion simplex MM PC, beige / black, 50 µm	3.0 mm
EAA 1057309	E-2000™ Fusion simplex MM PC, beige / beige, 62.5 µm	600 µm
EAA 1057310	E-2000™ Fusion simplex MM PC, beige / beige, 62.5 µm	900 µm
EAA 1057311	E-2000™ Fusion simplex MM PC, beige / beige, 62.5 µm	1.6 mm
EAA 1057312	E-2000™ Fusion simplex MM PC, beige / beige, 62.5 µm	2.1 mm
EAA 1057313	E-2000™ Fusion simplex MM PC, beige / beige, 62.5 µm	2.4 mm
EAA 1057314	E-2000™ Fusion simplex MM PC, beige / beige, 62.5 µm	3.0 mm
EAA 1057315	E-2000™ Fusion simplex SM PC, blue / blue, 9 µm	600 µm
EAA 1057316	E-2000™ Fusion simplex SM PC, blue / blue, 9 µm	900 µm
EAA 1057317	E-2000™ Fusion simplex SM PC, blue / blue, 9 µm	1.6 mm
EAA 1057318	E-2000™ Fusion simplex SM PC, blue / blue, 9 µm	2.1 mm
EAA 1057319	E-2000™ Fusion simplex SM PC, blue / blue, 9 µm	2.4 mm
EAA 1057320	E-2000™ Fusion simplex SM PC, blue / blue, 9 µm	3.0 mm
EAA 1057321	E-2000™ Fusion simplex SM APC, green / green, 9 µm	600 µm
EAA 1057322	E-2000™ Fusion simplex SM APC, green / green, 9 µm	900 µm
EAA 1057323	E-2000™ Fusion simplex SM APC, green / green, 9 µm	1.6 mm
EAA 1057324	E-2000™ Fusion simplex SM APC, green / green, 9 µm	2.1 mm
EAA 1057325	E-2000™ Fusion simplex SM APC, green / green, 9 µm	2.4 mm
EAA 1057326	E-2000™ Fusion simplex SM APC, green / green, 9 µm	3.0 mm
E-2000™ Fusion Compact		
EAA 1057327	E-2000™ Fusion compact MM PC, beige / black, 50 µm	600 µm
EAA 1057328	E-2000™ Fusion compact MM PC, beige / black, 50 µm	900 µm
EAA 1057329	E-2000™ Fusion compact MM PC, beige / black, 50 µm	1.6 mm
EAA 1057330	E-2000™ Fusion compact MM PC, beige / black, 50 µm	2.1 mm
EAA 1057331	E-2000™ Fusion compact MM PC, beige / black, 50 µm	2.4 mm
EAA 1057332	E-2000™ Fusion compact MM PC, beige / black, 50 µm	3.0 mm
EAA 1057333	E-2000™ Fusion compact MM PC, beige / beige, 62.5 µm	600 µm
EAA 1057334	E-2000™ Fusion compact MM PC, beige / beige, 62.5 µm	900 µm
EAA 1057335	E-2000™ Fusion compact MM PC, beige / beige, 62.5 µm	1.6 mm
EAA 1057336	E-2000™ Fusion compact MM PC, beige / beige, 62.5 µm	2.1 mm
EAA 1057337	E-2000™ Fusion compact MM PC, beige / beige, 62.5 µm	2.4 mm
EAA 1057338	E-2000™ Fusion compact MM PC, beige / beige, 62.5 µm	3.0 mm
EAA 1057341	E-2000™ Fusion compact SM PC, blue / blue, 9 µm	600 µm
EAA 1057342	E-2000™ Fusion compact SM PC, blue / blue, 9 µm	900 µm
EAA 1057343	E-2000™ Fusion compact SM PC, blue / blue, 9 µm	1.6 mm
EAA 1057344	E-2000™ Fusion compact SM PC, blue / blue, 9 µm	2.1 mm
EAA 1057345	E-2000™ Fusion compact SM PC, blue / blue, 9 µm	2.4 mm
EAA 1057346	E-2000™ Fusion compact SM PC, blue / blue, 9 µm	3.0 mm
EAA 1057347	E-2000™ Fusion compact SM APC, green / green, 9 µm	600 µm
EAA 1057348	E-2000™ Fusion compact SM APC, green / green, 9 µm	900 µm
EAA 1057349	E-2000™ Fusion compact SM APC, green / green, 9 µm	1.6 mm
EAA 1057350	E-2000™ Fusion compact SM APC, green / green, 9 µm	2.1 mm
EAA 1057351	E-2000™ Fusion compact SM APC, green / green, 9 µm	2.4 mm
EAA 1057352	E-2000™ Fusion compact SM APC, green / green, 9 µm	3.0 mm

Note: other housing and boot colors, as well as fiber/cable types upon request.

For adapter and fixing clips ordering information, please refer to the respective part-specific E-2000™ Simplex, Compact Mating Adapter P/N lists.

Version 0115

F-3000™ FUSION

F-3000™ Fusion Connector Gets Standard (with BI-adhesive alberino) P/Ns		
Order Number	Description (Type designation, housing/straight boot colors, fiber type)	Fibre/Cable
F-3000™ Fusion Simplex		
EAB 1057111	F-3000™ Fusion simplex MM PC, beige / black, 50 µm	600 µm
EAB 1057141	F-3000™ Fusion simplex MM PC, beige / black, 50 µm	900 µm
EAB 1057142	F-3000™ Fusion simplex MM PC, beige / black, 50 µm	1.6 mm
EAB 1057143	F-3000™ Fusion simplex MM PC, beige / black, 50 µm	2.1 mm
EAB 1057144	F-3000™ Fusion simplex MM PC, beige / black, 50 µm	2.4 mm
EAB 1057145	F-3000™ Fusion simplex MM PC, beige / black, 50 µm	3.0 mm
EAB 1057146	F-3000™ Fusion simplex MM PC, beige / beige, 62.5 µm	600 µm
EAB 1057147	F-3000™ Fusion simplex MM PC, beige / beige, 62.5 µm	900 µm
EAB 1057148	F-3000™ Fusion simplex MM PC, beige / beige, 62.5 µm	1.6 mm
EAB 1057149	F-3000™ Fusion simplex MM PC, beige / beige, 62.5 µm	2.1 mm
EAB 1057150	F-3000™ Fusion simplex MM PC, beige / beige, 62.5 µm	2.4 mm
EAB 1057151	F-3000™ Fusion simplex MM PC, beige / beige, 62.5 µm	3.0 mm
EAB 1057060	F-3000™ Fusion simplex SM PC, blue / blue, 9 µm	600 µm
EAB 1057092	F-3000™ Fusion simplex SM PC, blue / blue, 9 µm	900 µm
EAB 1057093	F-3000™ Fusion simplex SM PC, blue / blue, 9 µm	1.6 mm
EAB 1057094	F-3000™ Fusion simplex SM PC, blue / blue, 9 µm	2.1 mm
EAB 1057095	F-3000™ Fusion simplex SM PC, blue / blue, 9 µm	2.4 mm
EAB 1057096	F-3000™ Fusion simplex SM PC, blue / blue, 9 µm	3.0 mm
EAB 1055285	F-3000™ Fusion simplex SM APC, green / green, 9 µm	600 µm
EAB 1057097	F-3000™ Fusion simplex SM APC, green / green, 9 µm	900 µm
EAB 1055286	F-3000™ Fusion simplex SM APC, green / green, 9 µm	1.6 mm
EAB 1057098	F-3000™ Fusion simplex SM APC, green / green, 9 µm	2.1 mm
EAB 1057099	F-3000™ Fusion simplex SM APC, green / green, 9 µm	2.4 mm
EAB 1057100	F-3000™ Fusion simplex SM APC, green / green, 9 µm	3.0 mm
F-3000™ Fusion Duplex		
EAB 1057152	F-3000™ Fusion duplex MM PC, beige / black, 50 µm	600 µm
EAB 1057154	F-3000™ Fusion duplex MM PC, beige / black, 50 µm	900 µm
EAB 1057155	F-3000™ Fusion duplex MM PC, beige / black, 50 µm	1.6 mm
EAB 1057157	F-3000™ Fusion duplex MM PC, beige / black, 50 µm	2.1 mm
EAB 1057158	F-3000™ Fusion duplex MM PC, beige / black, 50 µm	2.4 mm
EAB 1057159	F-3000™ Fusion duplex MM PC, beige / black, 50 µm	3.0 mm
EAB 1057160	F-3000™ Fusion duplex MM PC, beige / beige, 62.5 µm	600 µm
EAB 1057161	F-3000™ Fusion duplex MM PC, beige / beige, 62.5 µm	900 µm
EAB 1057162	F-3000™ Fusion duplex MM PC, beige / beige, 62.5 µm	1.6 mm
EAB 1057163	F-3000™ Fusion duplex MM PC, beige / beige, 62.5 µm	2.1 mm
EAB 1057167	F-3000™ Fusion duplex MM PC, beige / beige, 62.5 µm	2.4 mm
EAB 1057170	F-3000™ Fusion duplex MM PC, beige / beige, 62.5 µm	3.0 mm
EAB 1057171	F-3000™ Fusion duplex SM PC, blue / blue, 9 µm	600 µm
EAB 1057172	F-3000™ Fusion duplex SM PC, blue / blue, 9 µm	900 µm
EAB 1057173	F-3000™ Fusion duplex SM PC, blue / blue, 9 µm	1.6 mm
EAB 1057174	F-3000™ Fusion duplex SM PC, blue / blue, 9 µm	2.1 mm
EAB 1057175	F-3000™ Fusion duplex SM PC, blue / blue, 9 µm	2.4 mm
EAB 1057176	F-3000™ Fusion duplex SM PC, blue / blue, 9 µm	3.0 mm
EAB 1057177	F-3000™ Fusion duplex SM APC, green / green, 9 µm	600 µm
EAB 1057181	F-3000™ Fusion duplex SM APC, green / green, 9 µm	900 µm
EAB 1057182	F-3000™ Fusion duplex SM APC, green / green, 9 µm	1.6 mm
EAB 1057183	F-3000™ Fusion duplex SM APC, green / green, 9 µm	2.1 mm
EAB 1057184	F-3000™ Fusion duplex SM APC, green / green, 9 µm	2.4 mm
EAB 1057185	F-3000™ Fusion duplex SM APC, green / green, 9 µm	3.0 mm

Note: other housing and boot colors, as well as fiber/cable types upon request.

For adapter and fixing clips ordering information, please refer to the respective part-specific F-3000™ Simplex, Duplex Mating Adapter P/N lists.

Version 0115

F-3000™s FUSION

F-3000™s Fusion Connector Gets Standard (with BI-adhesive alberino) P/Ns		
Order Number	Description (Type designation, housing/straight boot colors, fiber type)	Fibre/Cable
F-3000™ LCs Fusion Simplex		
EAB 1057186	F-3000™ s Fusion simplex MM PC, beige / black, 50 µm	600 µm
EAB 1057194	F-3000™ s Fusion simplex MM PC, beige / black, 50 µm	900 µm
EAB 1057195	F-3000™ s Fusion simplex MM PC, beige / black, 50 µm	1.6 mm
EAB 1057196	F-3000™ s Fusion simplex MM PC, beige / black, 50 µm	2.1 mm
EAB 1057198	F-3000™ s Fusion simplex MM PC, beige / black, 50 µm	2.4 mm
EAB 1057199	F-3000™ s Fusion simplex MM PC, beige / black, 50 µm	3.0 mm
EAB 1057200	F-3000™ s Fusion simplex MM PC, beige / beige, 62.5 µm	600 µm
EAB 1057202	F-3000™ s Fusion simplex MM PC, beige / beige, 62.5 µm	900 µm
EAB 1057203	F-3000™ s Fusion simplex MM PC, beige / beige, 62.5 µm	1.6 mm
EAB 1057204	F-3000™ s Fusion simplex MM PC, beige / beige, 62.5 µm	2.1 mm
EAB 1057206	F-3000™ s Fusion simplex MM PC, beige / beige, 62.5 µm	2.4 mm
EAB 1057208	F-3000™ s Fusion simplex MM PC, beige / beige, 62.5 µm	3.0 mm
EAB 1057210	F-3000™ s Fusion simplex SM PC, blue / blue, 9 µm	600 µm
EAB 1057211	F-3000™ s Fusion simplex SM PC, blue / blue, 9 µm	900 µm
EAB 1057212	F-3000™ s Fusion simplex SM PC, blue / blue, 9 µm	1.6 mm
EAB 1057213	F-3000™ s Fusion simplex SM PC, blue / blue, 9 µm	2.1 mm
EAB 1057214	F-3000™ s Fusion simplex SM PC, blue / blue, 9 µm	2.4 mm
EAB 1057215	F-3000™ s Fusion simplex SM PC, blue / blue, 9 µm	3.0 mm
EAB 1055287	F-3000™ s Fusion simplex SM APC, green / green, 9 µm	600 µm
EAB 1057217	F-3000™ s Fusion simplex SM APC, green / green, 9 µm	900 µm
EAB 1055288	F-3000™ s Fusion simplex SM APC, green / green, 9 µm	1.6 mm
EAB 1057218	F-3000™ s Fusion simplex SM APC, green / green, 9 µm	2.1 mm
EAB 1057219	F-3000™ s Fusion simplex SM APC, green / green, 9 µm	2.4 mm
EAB 1057220	F-3000™ s Fusion simplex SM APC, green / green, 9 µm	3.0 mm
F-3000™ s Fusion Duplex		
EAB Upon request	F-3000™ s Fusion duplex MM PC, beige / black, 50 µm	600 µm
EAB Upon request	F-3000™ s Fusion duplex MM PC, beige / black, 50 µm	900 µm
EAB Upon request	F-3000™ s Fusion duplex MM PC, beige / black, 50 µm	1.6 mm
EAB Upon request	F-3000™ s Fusion duplex MM PC, beige / black, 50 µm	2.1 mm
EAB Upon request	F-3000™ s Fusion duplex MM PC, beige / black, 50 µm	2.4 mm
EAB Upon request	F-3000™ s Fusion duplex MM PC, beige / black, 50 µm	3.0 mm
EAB Upon request	F-3000™ s Fusion duplex MM PC, beige / beige, 62.5 µm	600 µm
EAB Upon request	F-3000™ s Fusion duplex MM PC, beige / beige, 62.5 µm	900 µm
EAB Upon request	F-3000™ s Fusion duplex MM PC, beige / beige, 62.5 µm	1.6 mm
EAB Upon request	F-3000™ s Fusion duplex MM PC, beige / beige, 62.5 µm	2.1 mm
EAB Upon request	F-3000™ s Fusion duplex MM PC, beige / beige, 62.5 µm	2.4 mm
EAB Upon request	F-3000™ s Fusion duplex MM PC, beige / beige, 62.5 µm	3.0 mm
EAB Upon request	F-3000™ s Fusion duplex SM PC, blue / blue, 9 µm	600 µm
EAB Upon request	F-3000™ s Fusion duplex SM PC, blue / blue, 9 µm	900 µm
EAB Upon request	F-3000™ s Fusion duplex SM PC, blue / blue, 9 µm	1.6 mm
EAB Upon request	F-3000™ s Fusion duplex SM PC, blue / blue, 9 µm	2.1 mm
EAB Upon request	F-3000™ s Fusion duplex SM PC, blue / blue, 9 µm	2.4 mm
EAB Upon request	F-3000™ s Fusion duplex SM PC, blue / blue, 9 µm	3.0 mm
EAB Upon request	F-3000™ s Fusion duplex SM APC, green / green, 9 µm	600 µm
EAB Upon request	F-3000™ s Fusion duplex SM APC, green / green, 9 µm	900 µm
EAB Upon request	F-3000™ s Fusion duplex SM APC, green / green, 9 µm	1.6 mm
EAB Upon request	F-3000™ s Fusion duplex SM APC, green / green, 9 µm	2.1 mm
EAB Upon request	F-3000™ s Fusion duplex SM APC, green / green, 9 µm	2.4 mm
EAB Upon request	F-3000™ s Fusion duplex SM APC, green / green, 9 µm	3.0 mm

Note: other housing and boot colors, as well as fiber/cable types upon request.

For adapter and fixing clips ordering information, please refer to the respective part-specific F-3000™ Simplex, Duplex Mating Adapter P/N lists.

Version 0115

SC FUSION

SC Fusion Connector Sets Standard (with BI-adhesive alberino) P/Ns		
Order Number	Description (Type designation, housing/straight boot colors, fiber type)	Fibre/Cable
EAC 1057353	SC Fusion MM PC, beige / black, 50 µm	600 µm
EAC 1057354	SC Fusion MM PC, beige / black, 50 µm	900 µm
EAC 1057355	SC Fusion MM PC, beige / black, 50 µm	1.6 mm
EAC 1057356	SC Fusion MM PC, beige / black, 50 µm	2.1 mm
EAC 1057357	SC Fusion MM PC, beige / black, 50 µm	2.4 mm
EAC 1057358	SC Fusion MM PC, beige / black, 50 µm	3.0 mm
EAC 1057359	SC Fusion MM PC, beige / beige, 62.5 µm	600 µm
EAC 1057360	SC Fusion MM PC, beige / beige, 62.5 µm	900 µm
EAC 1057361	SC Fusion MM PC, beige / beige, 62.5 µm	1.6 mm
EAC 1057362	SC Fusion MM PC, beige / beige, 62.5 µm	2.1 mm
EAC 1057363	SC Fusion MM PC, beige / beige, 62.5 µm	2.4 mm
EAC 1057364	SC Fusion MM PC, beige / beige, 62.5 µm	3.0 mm
EAC 1057365	SC Fusion SM PC, blue / blue, 9 µm	600 µm
EAC 1057366	SC Fusion SM PC, blue / blue, 9 µm	900 µm
EAC 1057367	SC Fusion SM PC, blue / blue, 9 µm	1.6 mm
EAC 1057368	SC Fusion SM PC, blue / blue, 9 µm	2.1 mm
EAC 1057369	SC Fusion SM PC, blue / blue, 9 µm	2.4 mm
EAC 1057370	SC Fusion SM PC, blue / blue, 9 µm	3.0 mm
EAC 1057371	SC Fusion SM APC, green / green, 9 µm	600 µm
EAC 1057372	SC Fusion SM APC, green / green, 9 µm	900 µm
EAC 1057373	SC Fusion SM APC, green / green, 9 µm	1.6 mm
EAC 1057374	SC Fusion SM APC, green / green, 9 µm	2.1 mm
EAC 1057375	SC Fusion SM APC, green / green, 9 µm	2.4 mm
EAC 1057376	SC Fusion SM APC, green / green, 9 µm	3.0 mm

Note: other boot colors, as well as fiber/cable types upon request.

For adapter ordering information, please refer to the respective part-specific SC Mating Adapter P/N list.

Version 0115

FC FUSION

FC Fusion Connector Gets Standard (with BI-adhesive alberIno) P/Ns		
Order Number	Description (Type designation, key ø, straight boot colors, fiber type)	Fibre/Cable
EAI 1062948	FC Fusion MM PC, 2.14 mm, black, 50 µm	900 µm
EAI 1062949	FC Fusion MM PC, 2.14 mm, black, 50 µm	1.6 mm
EAI 1062951	FC Fusion MM PC, 2.14 mm, black, 50 µm	2.1 mm
EAI 1062953	FC Fusion MM PC, 2.14 mm, black, 50 µm	2.4 mm
EAI 1062954	FC Fusion MM PC, 2.14 mm black, 50 µm	3.0 mm
EAI 1062957	FC Fusion MM PC, 2.14 mm, beige, 62.5 µm	900 µm
EAI 1062958	FC Fusion MM PC, 2.14 mm, beige, 62.5 µm	1.6 mm
EAI 1062959	FC Fusion MM PC, 2.14 mm, beige, 62.5 µm	2.1 mm
EAI 1062963	FC Fusion MM PC, 2.14 mm, beige, 62.5 µm	2.4 mm
EAI 1062964	FC Fusion MM PC, 2.14 mm, beige, 62.5 µm	3.0 mm
EAI 1062931	FC Fusion SM PC, 2.14 mm, blue, 9 µm	900 µm
EAI 1062932	FC Fusion SM PC, 2.14 mm, blue, 9 µm	1.6 mm
EAI 1062933	FC Fusion SM PC, 2.14 mm, blue, 9 µm	2.1 mm
EAI 1062934	FC Fusion SM PC, 2.14 mm, blue, 9 µm	2.4 mm
EAI 1062935	FC Fusion SM PC, 2.14 mm, blue, 9 µm	3.0 mm
EAI 1062943	FC Fusion SM APC, 2 mm, green, 9 µm (JDS)	900 µm
EAI 1062944	FC Fusion SM APC, 2 mm, green, 9 µm (JDS)	1.6 mm
EAI 1062945	FC Fusion SM APC, 2 mm, green, 9 µm (JDS)	2.1 mm
EAI 1062946	FC Fusion SM APC, 2 mm, green, 9 µm (JDS)	2.4 mm
EAI 1062947	FC Fusion SM APC, 2 mm, green, 9 µm (JDS)	3.0 mm
EAI 1062936	FC Fusion SM APC, 2.14 mm, green, 9 µm	900 µm
EAI 1062937	FC Fusion SM APC, 2.14 mm, green, 9 µm	1.6 mm
EAI 1062938	FC Fusion SM APC, 2.14 mm, green, 9 µm	2.1 mm
EAI 1062939	FC Fusion SM APC, 2.14 mm, green, 9 µm	2.4 mm
EAI 1062940	FC Fusion SM APC, 2.14 mm, green, 9 µm	3.0 mm

Note: other boot colors, as well as fiber/cable types upon request.

For adapter ordering information, please refer to the respective part-specific FC Mating Adapter P/N list.

Version 0115

ST™ FUSION

ST™ Fusion Connector Sets Standard (with BI-adhesive alberIno) P/Ne		
Order Number	Description (Type designation, straight boot colors, fiber type)	Fibre/Cable
EAK 1062911	ST™ Fusion MM PC, black, 50 µm	900 µm
EAK 1062903	ST™ Fusion MM PC, black, 50 µm	1.6 mm
EAK 1062902	ST™ Fusion MM PC, black, 50 µm	2.1 mm
EAK 1062909	ST™ Fusion MM PC, black, 50 µm	2.4 mm
EAK 1062910	ST™ Fusion MM PC, black, 50 µm	3.0 mm
EAK 1062912	ST™ Fusion MM PC, beige, 62.5 µm	900 µm
EAK 1062913	ST™ Fusion MM PC, beige, 62.5 µm	1.6 mm
EAK 1062914	ST™ Fusion MM PC, beige, 62.5 µm	2.1 mm
EAK 1062915	ST™ Fusion MM PC, beige, 62.5 µm	2.4 mm
EAK 1062917	ST™ Fusion MM PC, beige, 62.5 µm	3.0 mm
EAK 1062898	ST™ Fusion SM PC, blue, 9 µm	900 µm
EAK 1062904	ST™ Fusion SM PC, blue, 9 µm	1.6 mm
EAK 1062906	ST™ Fusion SM PC, blue, 9 µm	2.1 mm
EAK 1062907	ST™ Fusion SM PC, blue, 9 µm	2.4 mm
EAK 1062908	ST™ Fusion SM PC, blue, 9 µm	3.0 mm

Note: other boot colors, as well as fiber/cable types upon request.

For adapter ordering information, please refer to the respective part-specific ST™ Mating Adapter P/N list.

Version 0115

FIELD TERMINATION

ZEUS D50 HE (Fusion Field Termination Kits)

Order Number	Description
GBB 1072435	ZEUS D50 HE Base kit (including E-2000 & F-3000 mounting tools up to 900um)
GBB 1072539	Assembling kit for OD3 on Zeus D50 HE
GBB 1072471	Assembling kit for X-Beam on Zeus D50 HE
GBB 1072474	Assembling kit for revoS E-2000™ on Zeus D50 HE
GBB 1075275	Assembling kit for F-3000™ ODVA on Zeus D50 HE
GY 1076418	Assembling kit for HE-2000 on Zeus D50 HE
GY 1076419	Assembling kit for MIL-38999 on Zeus D50 HE
GBB 1072476	Assembling kit for E-2000 & F-3000, 900-3000 on Zeus D50 HE
GBB 1072472	Assembling kit for SC 900-3000 on Zeus D50 HE
GBB 1072475	Assembling kit for FC 900-3000 on Zeus D50 HE
GBB 1072477	Assembling kit for ST™ 900-3000 on Zeus D50 HE
FBD 1059847	Assembling kit for Crocodile Splice Unit 900-3000 on Zeus D50 HE

Note: For spare parts and accessories, please contact your local Diamond representative.

E-2000™ FUSION

E-2000™ Fusion Connector Sets Standard (with Alberino HE) P/Ns		
Order Number	Description (Type designation, housing/straight boot colors, fiber type)	Fibre/Cable
E-2000™ Fusion Simplex		
EAA Upon request	E-2000™ Fusion simplex MM PC, beige / black, 50 µm	600 µm
EAA Upon request	E-2000™ Fusion simplex MM PC, beige / black, 50 µm	900 µm
EAA Upon request	E-2000™ Fusion simplex MM PC, beige / black, 50 µm	1.6 mm
EAA Upon request	E-2000™ Fusion simplex MM PC, beige / black, 50 µm	2.1 mm
EAA Upon request	E-2000™ Fusion simplex MM PC, beige / black, 50 µm	2.4 mm
EAA Upon request	E-2000™ Fusion simplex MM PC, beige / black, 50 µm	3.0 mm
EAA Upon request	E-2000™ Fusion simplex MM PC, beige / beige, 62.5 µm	600 µm
EAA Upon request	E-2000™ Fusion simplex MM PC, beige / beige, 62.5 µm	900 µm
EAA Upon request	E-2000™ Fusion simplex MM PC, beige / beige, 62.5 µm	1.6 mm
EAA Upon request	E-2000™ Fusion simplex MM PC, beige / beige, 62.5 µm	2.1 mm
EAA Upon request	E-2000™ Fusion simplex MM PC, beige / beige, 62.5 µm	2.4 mm
EAA Upon request	E-2000™ Fusion simplex MM PC, beige / beige, 62.5 µm	3.0 mm
EAA Upon request	E-2000™ Fusion simplex SM PC, blue / blue, 9 µm	600 µm
EAA Upon request	E-2000™ Fusion simplex SM PC, blue / blue, 9 µm	900 µm
EAA Upon request	E-2000™ Fusion simplex SM PC, blue / blue, 9 µm	1.6 mm
EAA Upon request	E-2000™ Fusion simplex SM PC, blue / blue, 9 µm	2.1 mm
EAA Upon request	E-2000™ Fusion simplex SM PC, blue / blue, 9 µm	2.4 mm
EAA Upon request	E-2000™ Fusion simplex SM PC, blue / blue, 9 µm	3.0 mm
EAA Upon request	E-2000™ Fusion simplex SM APC, green / green, 9 µm	600 µm
EAA Upon request	E-2000™ Fusion simplex SM APC, green / green, 9 µm	900 µm
EAA Upon request	E-2000™ Fusion simplex SM APC, green / green, 9 µm	1.6 mm
EAA Upon request	E-2000™ Fusion simplex SM APC, green / green, 9 µm	2.1 mm
EAA Upon request	E-2000™ Fusion simplex SM APC, green / green, 9 µm	2.4 mm
EAA Upon request	E-2000™ Fusion simplex SM APC, green / green, 9 µm	3.0 mm
E-2000™ Fusion Compact		
EAA Upon request	E-2000™ Fusion compact MM PC, beige / black, 50 µm	600 µm
EAA Upon request	E-2000™ Fusion compact MM PC, beige / black, 50 µm	900 µm
EAA Upon request	E-2000™ Fusion compact MM PC, beige / black, 50 µm	1.6 mm
EAA Upon request	E-2000™ Fusion compact MM PC, beige / black, 50 µm	2.1 mm
EAA Upon request	E-2000™ Fusion compact MM PC, beige / black, 50 µm	2.4 mm
EAA Upon request	E-2000™ Fusion compact MM PC, beige / black, 50 µm	3.0 mm
EAA Upon request	E-2000™ Fusion compact MM PC, beige / beige, 62.5 µm	600 µm
EAA Upon request	E-2000™ Fusion compact MM PC, beige / beige, 62.5 µm	900 µm
EAA Upon request	E-2000™ Fusion compact MM PC, beige / beige, 62.5 µm	1.6 mm
EAA Upon request	E-2000™ Fusion compact MM PC, beige / beige, 62.5 µm	2.1 mm
EAA Upon request	E-2000™ Fusion compact MM PC, beige / beige, 62.5 µm	2.4 mm
EAA Upon request	E-2000™ Fusion compact MM PC, beige / beige, 62.5 µm	3.0 mm
EAA Upon request	E-2000™ Fusion compact SM PC, blue / blue, 9 µm	600 µm
EAA Upon request	E-2000™ Fusion compact SM PC, blue / blue, 9 µm	900 µm
EAA Upon request	E-2000™ Fusion compact SM PC, blue / blue, 9 µm	1.6 mm
EAA Upon request	E-2000™ Fusion compact SM PC, blue / blue, 9 µm	2.1 mm
EAA Upon request	E-2000™ Fusion compact SM PC, blue / blue, 9 µm	2.4 mm
EAA Upon request	E-2000™ Fusion compact SM PC, blue / blue, 9 µm	3.0 mm
EAA Upon request	E-2000™ Fusion compact SM APC, green / green, 9 µm	600 µm
EAA Upon request	E-2000™ Fusion compact SM APC, green / green, 9 µm	900 µm
EAA Upon request	E-2000™ Fusion compact SM APC, green / green, 9 µm	1.6 mm
EAA Upon request	E-2000™ Fusion compact SM APC, green / green, 9 µm	2.1 mm
EAA Upon request	E-2000™ Fusion compact SM APC, green / green, 9 µm	2.4 mm
EAA Upon request	E-2000™ Fusion compact SM APC, green / green, 9 µm	3.0 mm

Note: other housing and boot colors, as well as fiber/cable types upon request.

For adapter and fixing clips ordering information, please refer to the respective part-specific E-2000™ Simplex, Compact Mating Adapter P/N lists.

Version 0115

F-3000™ FUSION

F-3000™ Fusion Connector Gets Standard (with Alberino HE) P/Ns		
Order Number	Description (Type designation, housing/straight boot colors, fiber type)	Fibre/Cable
F-3000™ Fusion Simplex		
EAB Upon request	F-3000™ Fusion simplex MM PC, beige / black, 50 µm	600 µm
EAB Upon request	F-3000™ Fusion simplex MM PC, beige / black, 50 µm	900 µm
EAB Upon request	F-3000™ Fusion simplex MM PC, beige / black, 50 µm	1.6 mm
EAB Upon request	F-3000™ Fusion simplex MM PC, beige / black, 50 µm	2.1 mm
EAB Upon request	F-3000™ Fusion simplex MM PC, beige / black, 50 µm	2.4 mm
EAB Upon request	F-3000™ Fusion simplex MM PC, beige / black, 50 µm	3.0 mm
EAB Upon request	F-3000™ Fusion simplex MM PC, beige / beige, 62.5 µm	600 µm
EAB Upon request	F-3000™ Fusion simplex MM PC, beige / beige, 62.5 µm	900 µm
EAB Upon request	F-3000™ Fusion simplex MM PC, beige / beige, 62.5 µm	1.6 mm
EAB Upon request	F-3000™ Fusion simplex MM PC, beige / beige, 62.5 µm	2.1 mm
EAB Upon request	F-3000™ Fusion simplex MM PC, beige / beige, 62.5 µm	2.4 mm
EAB Upon request	F-3000™ Fusion simplex MM PC, beige / beige, 62.5 µm	3.0 mm
EAB Upon request	F-3000™ Fusion simplex SM PC, blue / blue, 9 µm	600 µm
EAB Upon request	F-3000™ Fusion simplex SM PC, blue / blue, 9 µm	900 µm
EAB Upon request	F-3000™ Fusion simplex SM PC, blue / blue, 9 µm	1.6 mm
EAB Upon request	F-3000™ Fusion simplex SM PC, blue / blue, 9 µm	2.1 mm
EAB Upon request	F-3000™ Fusion simplex SM PC, blue / blue, 9 µm	2.4 mm
EAB Upon request	F-3000™ Fusion simplex SM PC, blue / blue, 9 µm	3.0 mm
EAB Upon request	F-3000™ Fusion simplex SM APC, green / green, 9 µm	600 µm
EAB Upon request	F-3000™ Fusion simplex SM APC, green / green, 9 µm	900 µm
EAB Upon request	F-3000™ Fusion simplex SM APC, green / green, 9 µm	1.6 mm
EAB Upon request	F-3000™ Fusion simplex SM APC, green / green, 9 µm	2.1 mm
EAB Upon request	F-3000™ Fusion simplex SM APC, green / green, 9 µm	2.4 mm
EAB Upon request	F-3000™ Fusion simplex SM APC, green / green, 9 µm	3.0 mm
F-3000™ Fusion Duplex		
EAB Upon request	F-3000™ Fusion duplex MM PC, beige / black, 50 µm	600 µm
EAB Upon request	F-3000™ Fusion duplex MM PC, beige / black, 50 µm	900 µm
EAB Upon request	F-3000™ Fusion duplex MM PC, beige / black, 50 µm	1.6 mm
EAB Upon request	F-3000™ Fusion duplex MM PC, beige / black, 50 µm	2.1 mm
EAB Upon request	F-3000™ Fusion duplex MM PC, beige / black, 50 µm	2.4 mm
EAB Upon request	F-3000™ Fusion duplex MM PC, beige / black, 50 µm	3.0 mm
EAB Upon request	F-3000™ Fusion duplex MM PC, beige / beige, 62.5 µm	600 µm
EAB Upon request	F-3000™ Fusion duplex MM PC, beige / beige, 62.5 µm	900 µm
EAB Upon request	F-3000™ Fusion duplex MM PC, beige / beige, 62.5 µm	1.6 mm
EAB Upon request	F-3000™ Fusion duplex MM PC, beige / beige, 62.5 µm	2.1 mm
EAB Upon request	F-3000™ Fusion duplex MM PC, beige / beige, 62.5 µm	2.4 mm
EAB Upon request	F-3000™ Fusion duplex MM PC, beige / beige, 62.5 µm	3.0 mm
EAB Upon request	F-3000™ Fusion duplex SM PC, blue / blue, 9 µm	600 µm
EAB Upon request	F-3000™ Fusion duplex SM PC, blue / blue, 9 µm	900 µm
EAB Upon request	F-3000™ Fusion duplex SM PC, blue / blue, 9 µm	1.6 mm
EAB Upon request	F-3000™ Fusion duplex SM PC, blue / blue, 9 µm	2.1 mm
EAB Upon request	F-3000™ Fusion duplex SM PC, blue / blue, 9 µm	2.4 mm
EAB Upon request	F-3000™ Fusion duplex SM PC, blue / blue, 9 µm	3.0 mm
EAB Upon request	F-3000™ Fusion duplex SM APC, green / green, 9 µm	600 µm
EAB Upon request	F-3000™ Fusion duplex SM APC, green / green, 9 µm	900 µm
EAB Upon request	F-3000™ Fusion duplex SM APC, green / green, 9 µm	1.6 mm
EAB Upon request	F-3000™ Fusion duplex SM APC, green / green, 9 µm	2.1 mm
EAB Upon request	F-3000™ Fusion duplex SM APC, green / green, 9 µm	2.4 mm
EAB Upon request	F-3000™ Fusion duplex SM APC, green / green, 9 µm	3.0 mm

Note: other housing and boot colors, as well as fiber/cable types upon request.

For adapter and fixing clips ordering information, please refer to the respective part-specific F-3000™ Simplex, Duplex Mating Adapter P/N lists.

Version 0115

F-3000™s FUSION

F-3000™s Fusion Connector Gets Standard (with Alberlno HE) P/Ns		
Order Number	Description (Type designation, housing/straight boot colors, fiber type)	Fibre/Cable
F-3000™ LCs Fusion Simplex		
EAB Upon request	F-3000™ s Fusion simplex MM PC, beige / black, 50 µm	600 µm
EAB Upon request	F-3000™ s Fusion simplex MM PC, beige / black, 50 µm	900 µm
EAB Upon request	F-3000™ s Fusion simplex MM PC, beige / black, 50 µm	1.6 mm
EAB Upon request	F-3000™ s Fusion simplex MM PC, beige / black, 50 µm	2.1 mm
EAB Upon request	F-3000™ s Fusion simplex MM PC, beige / black, 50 µm	2.4 mm
EAB Upon request	F-3000™ s Fusion simplex MM PC, beige / black, 50 µm	3.0 mm
EAB Upon request	F-3000™ s Fusion simplex MM PC, beige / beige, 62.5 µm	600 µm
EAB Upon request	F-3000™ s Fusion simplex MM PC, beige / beige, 62.5 µm	900 µm
EAB Upon request	F-3000™ s Fusion simplex MM PC, beige / beige, 62.5 µm	1.6 mm
EAB Upon request	F-3000™ s Fusion simplex MM PC, beige / beige, 62.5 µm	2.1 mm
EAB Upon request	F-3000™ s Fusion simplex MM PC, beige / beige, 62.5 µm	2.4 mm
EAB Upon request	F-3000™ s Fusion simplex MM PC, beige / beige, 62.5 µm	3.0 mm
EAB Upon request	F-3000™ s Fusion simplex SM PC, blue / blue, 9 µm	600 µm
EAB Upon request	F-3000™ s Fusion simplex SM PC, blue / blue, 9 µm	900 µm
EAB Upon request	F-3000™ s Fusion simplex SM PC, blue / blue, 9 µm	1.6 mm
EAB Upon request	F-3000™ s Fusion simplex SM PC, blue / blue, 9 µm	2.1 mm
EAB Upon request	F-3000™ s Fusion simplex SM PC, blue / blue, 9 µm	2.4 mm
EAB Upon request	F-3000™ s Fusion simplex SM PC, blue / blue, 9 µm	3.0 mm
EAB Upon request	F-3000™ s Fusion simplex SM APC, green / green, 9 µm	600 µm
EAB Upon request	F-3000™ s Fusion simplex SM APC, green / green, 9 µm	900 µm
EAB Upon request	F-3000™ s Fusion simplex SM APC, green / green, 9 µm	1.6 mm
EAB Upon request	F-3000™ s Fusion simplex SM APC, green / green, 9 µm	2.1 mm
EAB Upon request	F-3000™ s Fusion simplex SM APC, green / green, 9 µm	2.4 mm
EAB Upon request	F-3000™ s Fusion simplex SM APC, green / green, 9 µm	3.0 mm
F-3000™ s Fusion Duplex		
EAB Upon request	F-3000™ s Fusion duplex MM PC, beige / black, 50 µm	600 µm
EAB Upon request	F-3000™ s Fusion duplex MM PC, beige / black, 50 µm	900 µm
EAB Upon request	F-3000™ s Fusion duplex MM PC, beige / black, 50 µm	1.6 mm
EAB Upon request	F-3000™ s Fusion duplex MM PC, beige / black, 50 µm	2.1 mm
EAB Upon request	F-3000™ s Fusion duplex MM PC, beige / black, 50 µm	2.4 mm
EAB Upon request	F-3000™ s Fusion duplex MM PC, beige / black, 50 µm	3.0 mm
EAB Upon request	F-3000™ s Fusion duplex MM PC, beige / beige, 62.5 µm	600 µm
EAB Upon request	F-3000™ s Fusion duplex MM PC, beige / beige, 62.5 µm	900 µm
EAB Upon request	F-3000™ s Fusion duplex MM PC, beige / beige, 62.5 µm	1.6 mm
EAB Upon request	F-3000™ s Fusion duplex MM PC, beige / beige, 62.5 µm	2.1 mm
EAB Upon request	F-3000™ s Fusion duplex MM PC, beige / beige, 62.5 µm	2.4 mm
EAB Upon request	F-3000™ s Fusion duplex MM PC, beige / beige, 62.5 µm	3.0 mm
EAB Upon request	F-3000™ s Fusion duplex SM PC, blue / blue, 9 µm	600 µm
EAB Upon request	F-3000™ s Fusion duplex SM PC, blue / blue, 9 µm	900 µm
EAB Upon request	F-3000™ s Fusion duplex SM PC, blue / blue, 9 µm	1.6 mm
EAB Upon request	F-3000™ s Fusion duplex SM PC, blue / blue, 9 µm	2.1 mm
EAB Upon request	F-3000™ s Fusion duplex SM PC, blue / blue, 9 µm	2.4 mm
EAB Upon request	F-3000™ s Fusion duplex SM PC, blue / blue, 9 µm	3.0 mm
EAB Upon request	F-3000™ s Fusion duplex SM APC, green / green, 9 µm	600 µm
EAB Upon request	F-3000™ s Fusion duplex SM APC, green / green, 9 µm	900 µm
EAB Upon request	F-3000™ s Fusion duplex SM APC, green / green, 9 µm	1.6 mm
EAB Upon request	F-3000™ s Fusion duplex SM APC, green / green, 9 µm	2.1 mm
EAB Upon request	F-3000™ s Fusion duplex SM APC, green / green, 9 µm	2.4 mm
EAB Upon request	F-3000™ s Fusion duplex SM APC, green / green, 9 µm	3.0 mm

Note: other housing and boot colors, as well as fiber/cable types upon request.

For adapter and fixing clips ordering information, please refer to the respective part-specific F-3000™ Simplex, Duplex Mating Adapter P/N lists.

Version 0115

SC FUSION

SC Fusion Connector Sets Standard (with Alberino HE) P/Ns		
Order Number	Description (Type designation, housing/straight boot colors, fiber type)	Fibre/Cable
EAC Upon request	SC Fusion MM PC, beige / black, 50 µm	600 µm
EAC Upon request	SC Fusion MM PC, beige / black, 50 µm	900 µm
EAC Upon request	SC Fusion MM PC, beige / black, 50 µm	1.6 mm
EAC Upon request	SC Fusion MM PC, beige / black, 50 µm	2.1 mm
EAC Upon request	SC Fusion MM PC, beige / black, 50 µm	2.4 mm
EAC Upon request	SC Fusion MM PC, beige / black, 50 µm	3.0 mm
EAC Upon request	SC Fusion MM PC, beige / beige, 62.5 µm	600 µm
EAC Upon request	SC Fusion MM PC, beige / beige, 62.5 µm	900 µm
EAC Upon request	SC Fusion MM PC, beige / beige, 62.5 µm	1.6 mm
EAC Upon request	SC Fusion MM PC, beige / beige, 62.5 µm	2.1 mm
EAC Upon request	SC Fusion MM PC, beige / beige, 62.5 µm	2.4 mm
EAC Upon request	SC Fusion MM PC, beige / beige, 62.5 µm	3.0 mm
EAC Upon request	SC Fusion SM PC, blue / blue, 9 µm	600 µm
EAC Upon request	SC Fusion SM PC, blue / blue, 9 µm	900 µm
EAC Upon request	SC Fusion SM PC, blue / blue, 9 µm	1.6 mm
EAC Upon request	SC Fusion SM PC, blue / blue, 9 µm	2.1 mm
EAC Upon request	SC Fusion SM PC, blue / blue, 9 µm	2.4 mm
EAC Upon request	SC Fusion SM PC, blue / blue, 9 µm	3.0 mm
EAC Upon request	SC Fusion SM APC, green / green, 9 µm	600 µm
EAC Upon request	SC Fusion SM APC, green / green, 9 µm	900 µm
EAC Upon request	SC Fusion SM APC, green / green, 9 µm	1.6 mm
EAC Upon request	SC Fusion SM APC, green / green, 9 µm	2.1 mm
EAC Upon request	SC Fusion SM APC, green / green, 9 µm	2.4 mm
EAC Upon request	SC Fusion SM APC, green / green, 9 µm	3.0 mm

Note: other boot colors, as well as fiber/cable types upon request.

For adapter ordering information, please refer to the respective part-specific SC Mating Adapter P/N list.

Version 0115

FC FUSION

FC Fusion Connector Gets Standard (with Alberino HE)		
Order Number	Description (Type designation, key ø, straight boot colors, fiber type)	Fibre/Cable
EAI Upon request	FC Fusion MM PC, 2.14 mm, black, 50 µm	900 µm
EAI Upon request	FC Fusion MM PC, 2.14 mm, black, 50 µm	1.6 mm
EAI Upon request	FC Fusion MM PC, 2.14 mm, black, 50 µm	2.1 mm
EAI Upon request	FC Fusion MM PC, 2.14 mm, black, 50 µm	2.4 mm
EAI Upon request	FC Fusion MM PC, 2.14 mm black, 50 µm	3.0 mm
EAI Upon request	FC Fusion MM PC, 2.14 mm, beige, 62.5 µm	900 µm
EAI Upon request	FC Fusion MM PC, 2.14 mm, beige, 62.5 µm	1.6 mm
EAI Upon request	FC Fusion MM PC, 2.14 mm, beige, 62.5 µm	2.1 mm
EAI Upon request	FC Fusion MM PC, 2.14 mm, beige, 62.5 µm	2.4 mm
EAI Upon request	FC Fusion MM PC, 2.14 mm, beige, 62.5 µm	3.0 mm
EAI Upon request	FC Fusion SM PC, 2.14 mm, blue, 9 µm	900 µm
EAI Upon request	FC Fusion SM PC, 2.14 mm, blue, 9 µm	1.6 mm
EAI Upon request	FC Fusion SM PC, 2.14 mm, blue, 9 µm	2.1 mm
EAI Upon request	FC Fusion SM PC, 2.14 mm, blue, 9 µm	2.4 mm
EAI Upon request	FC Fusion SM PC, 2.14 mm, blue, 9 µm	3.0 mm
EAI Upon request	FC Fusion SM APC, 2 mm, green, 9 µm (JDS)	900 µm
EAI Upon request	FC Fusion SM APC, 2 mm, green, 9 µm (JDS)	1.6 mm
EAI Upon request	FC Fusion SM APC, 2 mm, green, 9 µm (JDS)	2.1 mm
EAI Upon request	FC Fusion SM APC, 2 mm, green, 9 µm (JDS)	2.4 mm
EAI Upon request	FC Fusion SM APC, 2 mm, green, 9 µm (JDS)	3.0 mm
EAI Upon request	FC Fusion SM APC, 2.14 mm, green, 9 µm	900 µm
EAI Upon request	FC Fusion SM APC, 2.14 mm, green, 9 µm	1.6 mm
EAI Upon request	FC Fusion SM APC, 2.14 mm, green, 9 µm	2.1 mm
EAI Upon request	FC Fusion SM APC, 2.14 mm, green, 9 µm	2.4 mm
EAI Upon request	FC Fusion SM APC, 2.14 mm, green, 9 µm	3.0 mm

Note: other boot colors, as well as fiber/cable types upon request.

For adapter ordering information, please refer to the respective part-specific FC Mating Adapter P/N list.

Version 0115

ST™ FUSION

ST™ Fusion Connector Gets Standard (with Alberino HE) P/Ns		
Order Number	Description (Type designation, straight boot colors, fiber type)	Fibre/Cable
EAK Upon request	ST™ Fusion MM PC, black, 50 µm	900 µm
EAK Upon request	ST™ Fusion MM PC, black, 50 µm	1.6 mm
EAK Upon request	ST™ Fusion MM PC, black, 50 µm	2.1 mm
EAK Upon request	ST™ Fusion MM PC, black, 50 µm	2.4 mm
EAK Upon request	ST™ Fusion MM PC, black, 50 µm	3.0 mm
EAK Upon request	ST™ Fusion MM PC, beige, 62.5 µm	900 µm
EAK Upon request	ST™ Fusion MM PC, beige, 62.5 µm	1.6 mm
EAK Upon request	ST™ Fusion MM PC, beige, 62.5 µm	2.1 mm
EAK Upon request	ST™ Fusion MM PC, beige, 62.5 µm	2.4 mm
EAK Upon request	ST™ Fusion MM PC, beige, 62.5 µm	3.0 mm
EAK Upon request	ST™ Fusion SM PC, blue, 9 µm	900 µm
EAK Upon request	ST™ Fusion SM PC, blue, 9 µm	1.6 mm
EAK Upon request	ST™ Fusion SM PC, blue, 9 µm	2.1 mm
EAK Upon request	ST™ Fusion SM PC, blue, 9 µm	2.4 mm
EAK Upon request	ST™ Fusion SM PC, blue, 9 µm	3.0 mm

Note: other boot colors, as well as fiber/cable types upon request.

For adapter ordering information, please refer to the respective part-specific ST™ Mating Adapter P/N list.

Version 0115

OUTDOOR/INDUSTRIAL





MIL-38999 connector housing sets (Including DM Insert)	
Order Number	Description
Upon request	Type 1 connector set for 5 mm cable
Upon request	Type 1 connector set for 5,5 mm cable
Upon request	Type 2 connector set
Upon request	Type 3 connector set
Upon request	Type 4 connector set
Upon request	Type 5 connector set
Upon request	Type 6 connector set





Alberini Fusionset MM 50µm for field assembly		Suitable connector type
Order Number	Description	
DCC 1075830	Alberino Fusion set for fiber (without boot)	1,2
DCC 1075843	Alberino Fusion set for fiber (with boot)	4,6
DCC 1075849	Alberino Fusion set for cable <2mm (600um fiber)	4,6
DCC 1075850	Alberino Fusion set for cable <2mm (900um fiber)	4,6
DCC 1075851	Alberino Fusion set for cable 2-3mm (600um fiber)	3,4,5,6
DCC 1075852	Alberino Fusion set for cable 2-3mm (900um fiber)	3,4,5,6

Alberini Fusionset MM 62.5µm for field assembly		Suitable connector type
Order Number	Description	
DCC 1070220	Alberino Fusion set for fiber (without boot)	1,2
DCC 1075844	Alberino Fusion set for fiber (with boot)	4,6
DCC 1075854	Alberino Fusion set for cable <2mm (600um fiber)	4,6
DCC 1075855	Alberino Fusion set for cable <2mm (900um fiber)	4,6
DCC 1075856	Alberino Fusion set for cable 2-3mm (600um fiber)	3,4,5,6
DCC 1075857	Alberino Fusion set for cable 2-3mm (900um fiber)	3,4,5,6

Alberini Fusion sets (SM PC) for field assembly		Suitable connector type
Order Number	Description	
DCC 1074826	Alberino Fusion set for fiber (without boot)	1,2
DCC 1075845	Alberino Fusion set for fiber (with boot)	4,6
DCC 1075860	Alberino Fusion set for cable <2mm (600um fiber)	4,6
DCC 1075861	Alberino Fusion set for cable <2mm (900um fiber)	4,6
DCC 1075862	Alberino Fusion set for cable 2-3mm (600um fiber)	3,4,5,6
DCC 1075863	Alberino Fusion set for cable 2-3mm (900um fiber)	3,4,5,6

Alberini Fusion sets (SM APC) for field assembly		Suitable connector type
Order Number	Description	
DCC 1074827	Alberino Fusion set for fiber (without boot)	1,2
DCC 1075846	Alberino Fusion set for fiber (with boot)	4,6
DCC 1075864	Alberino Fusion set for cable <2mm (600um fiber)	4,6
DCC 1075865	Alberino Fusion set for cable <2mm (900um fiber)	4,6
DCC 1075866	Alberino Fusion set for cable 2-3mm (600um fiber)	3,4,5,6
DCC 1075867	Alberino Fusion set for cable 2-3mm (900um fiber)	3,4,5,6

Other configuration components & spare parts			Suitable connector type
Order Number	Description		
EZ 1075868	Male Electrical termini set (including hollow pin + sleeve)	1,2,3,4,5,6	
EZ 1075869	Female Electrical termini set	1,2,3,4,5,6	
DBZ 1073767	Hollow pin + sleeve	1,2,3,4,5,6	
DBZ 1073781	Termini shell	1,2,3,4,5,6	
DAC 1073782	DM insert	1,2,3,4,5,6	
BEE 1074907	Metal cap for connector	1,2,3,4	
BEE 1074906	Metal cap for bulkhead	5,6	
BEE 1074903	Optional bulkhead gasket (Fluorosilicone, thickness 0.8mm)	5,6	

Tools			Suitable connector type
Order Number	Description		
GF 1074654	Termini extractor	Connector & Bulkhead	
GF 1074651	Alberino extractor	Connector & Bulkhead	
GF 1074680	Termini assembler	Connector & Bulkhead	
GF 1074744	Hollow pin tool	Connector & Bulkhead	

Version 515

OUTDOOR/INDUSTRIAL

HE-2000 connector housing sets (including DM insert)

Order Number	Description
EAT 1078051	Connector housing set for 5,5 mm cable (Type 1)
EBT 1078052	Bulkhead housing set (Type 2), gasket included

Alberini Fusionset MM 50µm for field assembly

Suitable connector type

Order Number	Description	
DCC 1075830	Alberino Fusion set for fiber (without boot)	Connector
DCC 1075843	Alberino Fusion set for fiber (with boot)	Bulkhead
DCC 1075849	Alberino Fusion set for cable <2mm (600um fiber)	Bulkhead
DCC 1075850	Alberino Fusion set for cable <2mm (900um fiber)	Bulkhead
DCC 1075851	Alberino Fusion set for cable 2-3mm (600um fiber)	Bulkhead
DCC 1075852	Alberino Fusion set for cable 2-3mm (900um fiber)	Bulkhead

Alberini Fusionset MM 62.5µm for field assembly

Suitable connector type

Order Number	Description	
DCC 1070220	Alberino Fusion set for fiber (without boot)	Connector
DCC 1075844	Alberino Fusion set for fiber (with boot)	Bulkhead
DCC 1075854	Alberino Fusion set for cable <2mm (600um fiber)	Bulkhead
DCC 1075855	Alberino Fusion set for cable <2mm (900um fiber)	Bulkhead
DCC 1075856	Alberino Fusion set for cable 2-3mm (600um fiber)	Bulkhead
DCC 1075857	Alberino Fusion set for cable 2-3mm (900um fiber)	Bulkhead

Alberini Fusion sets (SM PC) for field assembly







Suitable connector type





Order Number	Description	
DCD 1074826	Alberino Fusion set for fiber (without boot)	Connector
DCD 1075845	Alberino Fusion set for fiber (with boot)	Bulkhead
DCD 1075860	Alberino Fusion set for cable <2mm (600um fiber)	Bulkhead
DCD 1075861	Alberino Fusion set for cable <2mm (900um fiber)	Bulkhead
DCD 1075862	Alberino Fusion set for cable 2-3mm (600um fiber)	Bulkhead
DCD 1075863	Alberino Fusion set for cable 2-3mm (900um fiber)	Bulkhead

Alberini Fusion sets (SM APC) for field assembly

Suitable connector type

Order Number	Description	
DCC 1074827	Alberino Fusion set for fiber (without boot)	Connector
DCC 1075846	Alberino Fusion set for fiber (with boot)	Bulkhead
DCC 1075864	Alberino Fusion set for cable <2mm (600um fiber)	Bulkhead
DCC 1075865	Alberino Fusion set for cable <2mm (900um fiber)	Bulkhead
DCC 1075866	Alberino Fusion set for cable 2-3mm (600um fiber)	Bulkhead
DCC 1075867	Alberino Fusion set for cable 2-3mm (900um fiber)	Bulkhead

Other configuration components & spare parts			Suitable connector type
Order Number	Description		
EZ 1075868	Male Electrical termini set (including hollow pin + sleeve)	Connector & Bulkhead	
EZ 1075869	Female Electrical termini set	Connector & Bulkhead	
DBZ 1073767	Hollow pin + sleeve	Connector & Bulkhead	
DBZ 1073781	Termini shell	Connector & Bulkhead	
DAC 1073782	DM insert	Connector & Bulkhead	
BEE 1075788	Gasket (thickness: 1mm)	Bulkhead	
DBT 1078020	Connector protection cap	Connector	

Tools			Suitable connector type
Order Number	Description		
GF 1074654	Termini extractor	Connector & Bulkhead	
GF 1074651	Alberino extractor	Connector & Bulkhead	
GF 1074680	Termini assembler	Connector & Bulkhead	
GF 1074744	Hollow pin tool	Connector & Bulkhead	

E-2000™ FUSION

E-2000™ Fusion Connector Sets Standard (with BI-adhesive alberino) P/Ns		
Order Number	Description (Type designation, housing/straight boot colors, fiber type)	Fibre/Cable
E-2000™ Fusion Simplex		
EAA 1057246	E-2000™ Fusion simplex MM PC, beige / black, 50 µm	600 µm
EAA 1057247	E-2000™ Fusion simplex MM PC, beige / black, 50 µm	900 µm
EAA 1057248	E-2000™ Fusion simplex MM PC, beige / black, 50 µm	1.6 mm
EAA 1057249	E-2000™ Fusion simplex MM PC, beige / black, 50 µm	2.1 mm
EAA 1057250	E-2000™ Fusion simplex MM PC, beige / black, 50 µm	2.4 mm
EAA 1057251	E-2000™ Fusion simplex MM PC, beige / black, 50 µm	3.0 mm
EAA 1057309	E-2000™ Fusion simplex MM PC, beige / beige, 62.5 µm	600 µm
EAA 1057310	E-2000™ Fusion simplex MM PC, beige / beige, 62.5 µm	900 µm
EAA 1057311	E-2000™ Fusion simplex MM PC, beige / beige, 62.5 µm	1.6 mm
EAA 1057312	E-2000™ Fusion simplex MM PC, beige / beige, 62.5 µm	2.1 mm
EAA 1057313	E-2000™ Fusion simplex MM PC, beige / beige, 62.5 µm	2.4 mm
EAA 1057314	E-2000™ Fusion simplex MM PC, beige / beige, 62.5 µm	3.0 mm
EAA 1057315	E-2000™ Fusion simplex SM PC, blue / blue, 9 µm	600 µm
EAA 1057316	E-2000™ Fusion simplex SM PC, blue / blue, 9 µm	900 µm
EAA 1057317	E-2000™ Fusion simplex SM PC, blue / blue, 9 µm	1.6 mm
EAA 1057318	E-2000™ Fusion simplex SM PC, blue / blue, 9 µm	2.1 mm
EAA 1057319	E-2000™ Fusion simplex SM PC, blue / blue, 9 µm	2.4 mm
EAA 1057320	E-2000™ Fusion simplex SM PC, blue / blue, 9 µm	3.0 mm
EAA 1057321	E-2000™ Fusion simplex SM APC, green / green, 9 µm	600 µm
EAA 1057322	E-2000™ Fusion simplex SM APC, green / green, 9 µm	900 µm
EAA 1057323	E-2000™ Fusion simplex SM APC, green / green, 9 µm	1.6 mm
EAA 1057324	E-2000™ Fusion simplex SM APC, green / green, 9 µm	2.1 mm
EAA 1057325	E-2000™ Fusion simplex SM APC, green / green, 9 µm	2.4 mm
EAA 1057326	E-2000™ Fusion simplex SM APC, green / green, 9 µm	3.0 mm
E-2000™ Fusion Compact		
EAA 1057327	E-2000™ Fusion compact MM PC, beige / black, 50 µm	600 µm
EAA 1057328	E-2000™ Fusion compact MM PC, beige / black, 50 µm	900 µm
EAA 1057329	E-2000™ Fusion compact MM PC, beige / black, 50 µm	1.6 mm
EAA 1057330	E-2000™ Fusion compact MM PC, beige / black, 50 µm	2.1 mm
EAA 1057331	E-2000™ Fusion compact MM PC, beige / black, 50 µm	2.4 mm
EAA 1057332	E-2000™ Fusion compact MM PC, beige / black, 50 µm	3.0 mm
EAA 1057333	E-2000™ Fusion compact MM PC, beige / beige, 62.5 µm	600 µm
EAA 1057334	E-2000™ Fusion compact MM PC, beige / beige, 62.5 µm	900 µm
EAA 1057335	E-2000™ Fusion compact MM PC, beige / beige, 62.5 µm	1.6 mm
EAA 1057336	E-2000™ Fusion compact MM PC, beige / beige, 62.5 µm	2.1 mm
EAA 1057337	E-2000™ Fusion compact MM PC, beige / beige, 62.5 µm	2.4 mm
EAA 1057338	E-2000™ Fusion compact MM PC, beige / beige, 62.5 µm	3.0 mm
EAA 1057341	E-2000™ Fusion compact SM PC, blue / blue, 9 µm	600 µm
EAA 1057342	E-2000™ Fusion compact SM PC, blue / blue, 9 µm	900 µm
EAA 1057343	E-2000™ Fusion compact SM PC, blue / blue, 9 µm	1.6 mm
EAA 1057344	E-2000™ Fusion compact SM PC, blue / blue, 9 µm	2.1 mm
EAA 1057345	E-2000™ Fusion compact SM PC, blue / blue, 9 µm	2.4 mm
EAA 1057346	E-2000™ Fusion compact SM PC, blue / blue, 9 µm	3.0 mm
EAA 1057347	E-2000™ Fusion compact SM APC, green / green, 9 µm	600 µm
EAA 1057348	E-2000™ Fusion compact SM APC, green / green, 9 µm	900 µm
EAA 1057349	E-2000™ Fusion compact SM APC, green / green, 9 µm	1.6 mm
EAA 1057350	E-2000™ Fusion compact SM APC, green / green, 9 µm	2.1 mm
EAA 1057351	E-2000™ Fusion compact SM APC, green / green, 9 µm	2.4 mm
EAA 1057352	E-2000™ Fusion compact SM APC, green / green, 9 µm	3.0 mm

Note: other housing and boot colors, as well as fiber/cable types upon request.

For adapter and fixing clips ordering information, please refer to the respective part-specific E-2000™ Simplex, Compact Mating Adapter P/N lists.

Version 1114

F-3000™ FUSION

F-3000™ Fusion Connector Sets Standard (with BI-adhesive alberino) P/Ns		
Order Number	Description (Type designation, housing/straight boot colors, fiber type)	Fibre/Cable
F-3000™ Fusion Simplex		
EAB 1057111	F-3000™ Fusion simplex MM PC, beige / black, 50 µm	600 µm
EAB 1057141	F-3000™ Fusion simplex MM PC, beige / black, 50 µm	900 µm
EAB 1057142	F-3000™ Fusion simplex MM PC, beige / black, 50 µm	1.6 mm
EAB 1057143	F-3000™ Fusion simplex MM PC, beige / black, 50 µm	2.1 mm
EAB 1057144	F-3000™ Fusion simplex MM PC, beige / black, 50 µm	2.4 mm
EAB 1057145	F-3000™ Fusion simplex MM PC, beige / black, 50 µm	3.0 mm
EAB 1057146	F-3000™ Fusion simplex MM PC, beige / beige, 62.5 µm	600 µm
EAB 1057147	F-3000™ Fusion simplex MM PC, beige / beige, 62.5 µm	900 µm
EAB 1057148	F-3000™ Fusion simplex MM PC, beige / beige, 62.5 µm	1.6 mm
EAB 1057149	F-3000™ Fusion simplex MM PC, beige / beige, 62.5 µm	2.1 mm
EAB 1057150	F-3000™ Fusion simplex MM PC, beige / beige, 62.5 µm	2.4 mm
EAB 1057151	F-3000™ Fusion simplex MM PC, beige / beige, 62.5 µm	3.0 mm
EAB 1057060	F-3000™ Fusion simplex SM PC, blue / blue, 9 µm	600 µm
EAB 1057092	F-3000™ Fusion simplex SM PC, blue / blue, 9 µm	900 µm
EAB 1057093	F-3000™ Fusion simplex SM PC, blue / blue, 9 µm	1.6 mm
EAB 1057094	F-3000™ Fusion simplex SM PC, blue / blue, 9 µm	2.1 mm
EAB 1057095	F-3000™ Fusion simplex SM PC, blue / blue, 9 µm	2.4 mm
EAB 1057096	F-3000™ Fusion simplex SM PC, blue / blue, 9 µm	3.0 mm
EAB 1055285	F-3000™ Fusion simplex SM APC, green / green, 9 µm	600 µm
EAB 1057097	F-3000™ Fusion simplex SM APC, green / green, 9 µm	900 µm
EAB 1055286	F-3000™ Fusion simplex SM APC, green / green, 9 µm	1.6 mm
EAB 1057098	F-3000™ Fusion simplex SM APC, green / green, 9 µm	2.1 mm
EAB 1057099	F-3000™ Fusion simplex SM APC, green / green, 9 µm	2.4 mm
EAB 1057100	F-3000™ Fusion simplex SM APC, green / green, 9 µm	3.0 mm
F-3000™ Fusion Duplex		
EAB 1057152	F-3000™ Fusion duplex MM PC, beige / black, 50 µm	600 µm
EAB 1057154	F-3000™ Fusion duplex MM PC, beige / black, 50 µm	900 µm
EAB 1057155	F-3000™ Fusion duplex MM PC, beige / black, 50 µm	1.6 mm
EAB 1057157	F-3000™ Fusion duplex MM PC, beige / black, 50 µm	2.1 mm
EAB 1057158	F-3000™ Fusion duplex MM PC, beige / black, 50 µm	2.4 mm
EAB 1057159	F-3000™ Fusion duplex MM PC, beige / black, 50 µm	3.0 mm
EAB 1057160	F-3000™ Fusion duplex MM PC, beige / beige, 62.5 µm	600 µm
EAB 1057161	F-3000™ Fusion duplex MM PC, beige / beige, 62.5 µm	900 µm
EAB 1057162	F-3000™ Fusion duplex MM PC, beige / beige, 62.5 µm	1.6 mm
EAB 1057163	F-3000™ Fusion duplex MM PC, beige / beige, 62.5 µm	2.1 mm
EAB 1057167	F-3000™ Fusion duplex MM PC, beige / beige, 62.5 µm	2.4 mm
EAB 1057170	F-3000™ Fusion duplex MM PC, beige / beige, 62.5 µm	3.0 mm
EAB 1057171	F-3000™ Fusion duplex SM PC, blue / blue, 9 µm	600 µm
EAB 1057172	F-3000™ Fusion duplex SM PC, blue / blue, 9 µm	900 µm
EAB 1057173	F-3000™ Fusion duplex SM PC, blue / blue, 9 µm	1.6 mm
EAB 1057174	F-3000™ Fusion duplex SM PC, blue / blue, 9 µm	2.1 mm
EAB 1057175	F-3000™ Fusion duplex SM PC, blue / blue, 9 µm	2.4 mm
EAB 1057176	F-3000™ Fusion duplex SM PC, blue / blue, 9 µm	3.0 mm
EAB 1057177	F-3000™ Fusion duplex SM APC, green / green, 9 µm	600 µm
EAB 1057181	F-3000™ Fusion duplex SM APC, green / green, 9 µm	900 µm
EAB 1057182	F-3000™ Fusion duplex SM APC, green / green, 9 µm	1.6 mm
EAB 1057183	F-3000™ Fusion duplex SM APC, green / green, 9 µm	2.1 mm
EAB 1057184	F-3000™ Fusion duplex SM APC, green / green, 9 µm	2.4 mm
EAB 1057185	F-3000™ Fusion duplex SM APC, green / green, 9 µm	3.0 mm

Note: other housing and boot colors, as well as fiber/cable types upon request.

For adapter and fixing clips ordering information, please refer to the respective part-specific F-3000™ Simplex, Duplex Mating Adapter P/N lists.

Version 1114

F-3000™s FUSION

F-3000™s Fusion Connector Sets Standard (with BI-adhesive alberino) P/Ns		
Order Number	Description (Type designation, housing/straight boot colors, fiber type)	Fibre/Cable
F-3000™ LCs Fusion Simplex		
EAB 1057186	F-3000™ s Fusion simplex MM PC, beige / black, 50 µm	600 µm
EAB 1057194	F-3000™ s Fusion simplex MM PC, beige / black, 50 µm	900 µm
EAB 1057195	F-3000™ s Fusion simplex MM PC, beige / black, 50 µm	1.6 mm
EAB 1057196	F-3000™ s Fusion simplex MM PC, beige / black, 50 µm	2.1 mm
EAB 1057198	F-3000™ s Fusion simplex MM PC, beige / black, 50 µm	2.4 mm
EAB 1057199	F-3000™ s Fusion simplex MM PC, beige / black, 50 µm	3.0 mm
EAB 1057200	F-3000™ s Fusion simplex MM PC, beige / beige, 62.5 µm	600 µm
EAB 1057202	F-3000™ s Fusion simplex MM PC, beige / beige, 62.5 µm	900 µm
EAB 1057203	F-3000™ s Fusion simplex MM PC, beige / beige, 62.5 µm	1.6 mm
EAB 1057204	F-3000™ s Fusion simplex MM PC, beige / beige, 62.5 µm	2.1 mm
EAB 1057206	F-3000™ s Fusion simplex MM PC, beige / beige, 62.5 µm	2.4 mm
EAB 1057208	F-3000™ s Fusion simplex MM PC, beige / beige, 62.5 µm	3.0 mm
EAB 1057210	F-3000™ s Fusion simplex SM PC, blue / blue, 9 µm	600 µm
EAB 1057211	F-3000™ s Fusion simplex SM PC, blue / blue, 9 µm	900 µm
EAB 1057212	F-3000™ s Fusion simplex SM PC, blue / blue, 9 µm	1.6 mm
EAB 1057213	F-3000™ s Fusion simplex SM PC, blue / blue, 9 µm	2.1 mm
EAB 1057214	F-3000™ s Fusion simplex SM PC, blue / blue, 9 µm	2.4 mm
EAB 1057215	F-3000™ s Fusion simplex SM PC, blue / blue, 9 µm	3.0 mm
EAB 1055287	F-3000™ s Fusion simplex SM APC, green / green, 9 µm	600 µm
EAB 1057217	F-3000™ s Fusion simplex SM APC, green / green, 9 µm	900 µm
EAB 1055288	F-3000™ s Fusion simplex SM APC, green / green, 9 µm	1.6 mm
EAB 1057218	F-3000™ s Fusion simplex SM APC, green / green, 9 µm	2.1 mm
EAB 1057219	F-3000™ s Fusion simplex SM APC, green / green, 9 µm	2.4 mm
EAB 1057220	F-3000™ s Fusion simplex SM APC, green / green, 9 µm	3.0 mm
F-3000™ s Fusion Duplex		
EAB up on request	F-3000™ s Fusion duplex MM PC, beige / black, 50 µm	600 µm
EAB up on request	F-3000™ s Fusion duplex MM PC, beige / black, 50 µm	900 µm
EAB up on request	F-3000™ s Fusion duplex MM PC, beige / black, 50 µm	1.6 mm
EAB up on request	F-3000™ s Fusion duplex MM PC, beige / black, 50 µm	2.1 mm
EAB up on request	F-3000™ s Fusion duplex MM PC, beige / black, 50 µm	2.4 mm
EAB up on request	F-3000™ s Fusion duplex MM PC, beige / black, 50 µm	3.0 mm
EAB up on request	F-3000™ s Fusion duplex MM PC, beige / beige, 62.5 µm	600 µm
EAB up on request	F-3000™ s Fusion duplex MM PC, beige / beige, 62.5 µm	900 µm
EAB up on request	F-3000™ s Fusion duplex MM PC, beige / beige, 62.5 µm	1.6 mm
EAB up on request	F-3000™ s Fusion duplex MM PC, beige / beige, 62.5 µm	2.1 mm
EAB up on request	F-3000™ s Fusion duplex MM PC, beige / beige, 62.5 µm	2.4 mm
EAB up on request	F-3000™ s Fusion duplex MM PC, beige / beige, 62.5 µm	3.0 mm
EAB up on request	F-3000™ s Fusion duplex SM PC, blue / blue, 9 µm	600 µm
EAB up on request	F-3000™ s Fusion duplex SM PC, blue / blue, 9 µm	900 µm
EAB up on request	F-3000™ s Fusion duplex SM PC, blue / blue, 9 µm	1.6 mm
EAB up on request	F-3000™ s Fusion duplex SM PC, blue / blue, 9 µm	2.1 mm
EAB up on request	F-3000™ s Fusion duplex SM PC, blue / blue, 9 µm	2.4 mm
EAB up on request	F-3000™ s Fusion duplex SM PC, blue / blue, 9 µm	3.0 mm
EAB up on request	F-3000™ s Fusion duplex SM APC, green / green, 9 µm	600 µm
EAB up on request	F-3000™ s Fusion duplex SM APC, green / green, 9 µm	900 µm
EAB up on request	F-3000™ s Fusion duplex SM APC, green / green, 9 µm	1.6 mm
EAB up on request	F-3000™ s Fusion duplex SM APC, green / green, 9 µm	2.1 mm
EAB up on request	F-3000™ s Fusion duplex SM APC, green / green, 9 µm	2.4 mm
EAB up on request	F-3000™ s Fusion duplex SM APC, green / green, 9 µm	3.0 mm

Note: other housing and boot colors, as well as fiber/cable types upon request.

For adapter and fixing clips ordering information, please refer to the respective part-specific F-3000™ Simplex, Duplex Mating Adapter P/N lists.

Version 1114

SC FUSION

SC Fusion Connector Sets Standard (with BI-adhesive alberino) P/Ns		
Order Number	Description (Type designation, housing/straight boot colors, fiber type)	Fibre/Cable
EAC 1057353	SC Fusion MM PC, beige / black, 50 µm	600 µm
EAC 1057354	SC Fusion MM PC, beige / black, 50 µm	900 µm
EAC 1057355	SC Fusion MM PC, beige / black, 50 µm	1.6 mm
EAC 1057356	SC Fusion MM PC, beige / black, 50 µm	2.1 mm
EAC 1057357	SC Fusion MM PC, beige / black, 50 µm	2.4 mm
EAC 1057358	SC Fusion MM PC, beige / black, 50 µm	3.0 mm
EAC 1057359	SC Fusion MM PC, beige / beige, 62.5 µm	600 µm
EAC 1057360	SC Fusion MM PC, beige / beige, 62.5 µm	900 µm
EAC 1057361	SC Fusion MM PC, beige / beige, 62.5 µm	1.6 mm
EAC 1057362	SC Fusion MM PC, beige / beige, 62.5 µm	2.1 mm
EAC 1057363	SC Fusion MM PC, beige / beige, 62.5 µm	2.4 mm
EAC 1057364	SC Fusion MM PC, beige / beige, 62.5 µm	3.0 mm
EAC 1057365	SC Fusion SM PC, blue / blue, 9 µm	600 µm
EAC 1057366	SC Fusion SM PC, blue / blue, 9 µm	900 µm
EAC 1057367	SC Fusion SM PC, blue / blue, 9 µm	1.6 mm
EAC 1057368	SC Fusion SM PC, blue / blue, 9 µm	2.1 mm
EAC 1057369	SC Fusion SM PC, blue / blue, 9 µm	2.4 mm
EAC 1057370	SC Fusion SM PC, blue / blue, 9 µm	3.0 mm
EAC 1057371	SC Fusion SM APC, green / green, 9 µm	600 µm
EAC 1057372	SC Fusion SM APC, green / green, 9 µm	900 µm
EAC 1057373	SC Fusion SM APC, green / green, 9 µm	1.6 mm
EAC 1057374	SC Fusion SM APC, green / green, 9 µm	2.1 mm
EAC 1057375	SC Fusion SM APC, green / green, 9 µm	2.4 mm
EAC 1057376	SC Fusion SM APC, green / green, 9 µm	3.0 mm

Note: other boot colors, as well as fiber/cable types upon request.

For adapter ordering information, please refer to the respective part-specific SC Mating Adapter P/N list.

Version 1114

FC FUSION

FC Fusion Connector Sets Standard (with Bi-adhesive alberlino)		
Order Number	Description (Type designation, key ø, straight boot colors, fiber type)	Fibre/Cable
EAI 1062948	FC Fusion MM PC, 2.14 mm, black, 50 µm	900 µm
EAI 1062949	FC Fusion MM PC, 2.14 mm, black, 50 µm	1.6 mm
EAI 1062951	FC Fusion MM PC, 2.14 mm, black, 50 µm	2.1 mm
EAI 1062953	FC Fusion MM PC, 2.14 mm, black, 50 µm	2.4 mm
EAI 1062954	FC Fusion MM PC, 2.14 mm black, 50 µm	3.0 mm
EAI 1062957	FC Fusion MM PC, 2.14 mm, beige, 62.5 µm	900 µm
EAI 1062958	FC Fusion MM PC, 2.14 mm, beige, 62.5 µm	1.6 mm
EAI 1062959	FC Fusion MM PC, 2.14 mm, beige, 62.5 µm	2.1 mm
EAI 1062963	FC Fusion MM PC, 2.14 mm, beige, 62.5 µm	2.4 mm
EAI 1062964	FC Fusion MM PC, 2.14 mm, beige, 62.5 µm	3.0 mm
EAI 1062931	FC Fusion SM PC, 2.14 mm, blue, 9 µm	900 µm
EAI 1062932	FC Fusion SM PC, 2.14 mm, blue, 9 µm	1.6 mm
EAI 1062933	FC Fusion SM PC, 2.14 mm, blue, 9 µm	2.1 mm
EAI 1062934	FC Fusion SM PC, 2.14 mm, blue, 9 µm	2.4 mm
EAI 1062935	FC Fusion SM PC, 2.14 mm, blue, 9 µm	3.0 mm
EAI 1062943	FC Fusion SM APC, 2 mm, green, 9 µm (JDS)	900 µm
EAI 1062944	FC Fusion SM APC, 2 mm, green, 9 µm (JDS)	1.6 mm
EAI 1062945	FC Fusion SM APC, 2 mm, green, 9 µm (JDS)	2.1 mm
EAI 1062946	FC Fusion SM APC, 2 mm, green, 9 µm (JDS)	2.4 mm
EAI 1062947	FC Fusion SM APC, 2 mm, green, 9 µm (JDS)	3.0 mm
EAI 1062936	FC Fusion SM APC, 2.14 mm, green, 9 µm	900 µm
EAI 1062937	FC Fusion SM APC, 2.14 mm, green, 9 µm	1.6 mm
EAI 1062938	FC Fusion SM APC, 2.14 mm, green, 9 µm	2.1 mm
EAI 1062939	FC Fusion SM APC, 2.14 mm, green, 9 µm	2.4 mm
EAI 1062940	FC Fusion SM APC, 2.14 mm, green, 9 µm	3.0 mm

Note: other boot colors, as well as fiber/cable types upon request.

For adapter ordering information, please refer to the respective part-specific FC Mating Adapter P/N list.

Version 1114

ST™ FUSION

ST™ Fusion Connector Sets Standard (with BI-adhesive alberino) P/Ne		
Order Number	Description (Type designation, straight boot colors, fiber type)	Fibre/Cable
EAK 1062911	ST™ Fusion MM PC, black, 50 µm	900 µm
EAK 1062903	ST™ Fusion MM PC, black, 50 µm	1.6 mm
EAK 1062902	ST™ Fusion MM PC, black, 50 µm	2.1 mm
EAK 1062909	ST™ Fusion MM PC, black, 50 µm	2.4 mm
EAK 1062910	ST™ Fusion MM PC, black, 50 µm	3.0 mm
EAK 1062912	ST™ Fusion MM PC, beige, 62.5 µm	900 µm
EAK 1062913	ST™ Fusion MM PC, beige, 62.5 µm	1.6 mm
EAK 1062914	ST™ Fusion MM PC, beige, 62.5 µm	2.1 mm
EAK 1062915	ST™ Fusion MM PC, beige, 62.5 µm	2.4 mm
EAK 1062917	ST™ Fusion MM PC, beige, 62.5 µm	3.0 mm
EAK 1062898	ST™ Fusion SM PC, blue, 9 µm	900 µm
EAK 1062904	ST™ Fusion SM PC, blue, 9 µm	1.6 mm
EAK 1062906	ST™ Fusion SM PC, blue, 9 µm	2.1 mm
EAK 1062907	ST™ Fusion SM PC, blue, 9 µm	2.4 mm
EAK 1062908	ST™ Fusion SM PC, blue, 9 µm	3.0 mm

Note: other boot colors, as well as fiber/cable types upon request.

For adapter ordering information, please refer to the respective part-specific ST™ Mating Adapter P/N list.

Version 1114

FIELD TERMINATION

Alberino Tool Set	
Order Number	Description
ALBERINO TOOL SET	
GBA 1037274	Complete kit, with mounting pliers for PC and APC bodies and E-2000™, SC, FC, ST adapters
GBA 1063010	Kit, with mounting pliers, without adapters
GBA 1051151	Mounting pliers for PC and APC bodies (without adapters)
FBD 1028792	Adapter E-2000™ PC/APC for mounting pliers
FBD 1028788	Adapter SC PC/APC for mounting pliers
FBD 1028790	Adapter FC PC/APC for mounting pliers
FBD 1028791	Adapter ST PC for mounting pliers
BDC 1750121	Plastic box (empty)
BDA 1035425	Optic Pad
OPTIONS	
GBZ 1038981	CLETOP-S esay clean cassette
BCC 1030609	2,5mm Ferrule Cleaner
BEZ 1005104	Visual Fault Locator (VFL)
GBB 1070070	Microscopio FMD-200 including universal adapter ø1.25 + 2.5mm
Microscope adapters (Options)	
FBA 1070129	Universal adapter ø 1.25 mm
FBA 1070134	Universal adapter ø 2.5 mm
FBA 1070056	Adapter E-2000™ PC/APC
FBA 1070055	Adapter F-3000™ PC/APC
FBA 1072305	Adapter FSMA

Notes: For additional housings, spare parts, dust caps, cable boots etc., please contact your local Diamond representative.
Other Adapters available upon request.

Version 129

INSPECTION EQUIPMENTS

DIAMOND Video Inspection Microscope Kit	
Order Number	Description
SETS	
GY 1074529	Complete Kit. Video inspection microscope, cleaning kit, inspection probe P5000i, carrying case, universal adt. 1.25 mm & 2.5mm PC/APC for free connectors, and SC, LC (PC) adapters for in-adapter connectors
GC 1073490	Video microscope with inspection probe, including SC, LC (PC) adapters for in-adapter connectors, universal adapter tip 1.25mm and 2.5mm (PC) for free connector and soft bag.
GC 1074601	Inspection probe, including SC, LC (PC) adapters for in-adapter connectors, universal adapter tip 2.5mm (PC) for free connector and soft padded pouch
Optional adapters for video inspection microscope for free connectors	
BEZ 1071628	Visual Fault Locator (ML3) Pen style
BEZ 1067799	Adapter 2.5mm --> 1.25mm for Visual Fault Locator
BCC 1030609	Seikoh Giken Ferrule cleaner 2.5 mm
BCC 1038865	Seikoh Giken Ferrule cleaner 1.25 mm
Optional adapters for video inspection microscope for free connectors	
GBB 1070055	F-3000™ Adapter APC/PC for free simplex connectors
BCD 1072305	F-SMA Adapter PC for free simplex connectors
GBB 1074260	F-3000™ Adapter APC/PC for free duplex connectors
GBB 1075023	E-2000™ Adapter APC/PC for free simplex/duplex/Revos connectors
Optional in-adapters for inspection probe	
GC 1078533	E-2000™, HE-2000™, MIL-38999 APC/PC for in-adapter and DM insert
GC 1074602	F-3000™ PC for in-adapter
GC 1074608	F-3000 APC for in-adapter
GC 1074605	FC PC for in-adapter
GC 1074603	FC APC for in-adapter
GC 1074606	SC PC for in-adapter
GC 1074607	SC APC for in-adapter
GC 1074604	ST PC for in-adapter
DAA 1079313	Mini AVIM PC for in-adapter
DAA 1079317	Mini AVIM APC for in-adapter
Optional adapters for free connectors for Inspection Probe	
GC 1074970	1.25mm PC for free connector
GC 1074972	1.25mm APC for free connector
GC 1074969	2.5mm PC for free connector
GC 1074971	2.5mm APC for free connector
GC 1074973	Adapter for ELIO socket inspection for free connector

Version 0816

INSPECTION EQUIPMENTS

Cleaning Kit		
Order Number	Description	
CLEANING KIT		
GBB 1069731	Complete kit	
BCD 1070070	Inspection microscope with universal adapter \varnothing 2.5 mm, \varnothing 1.25 mm (without soft case)	
BCD 1070129	Universal adapter \varnothing 1.25mm	
BCD 1070134	Universal adapter \varnothing 2.5mm	
BDA 1038981	CLETOP esay clean cassette Type B	
BDA 1038970	Replacement reel for Cletop Cassette Cleaner Type B	
BDA 1065369	Cletop cleaning sticks L=150mm \varnothing 2.5 5pcs	
BDA 1020857	Cletop cleaning sticks L=150mm \varnothing 1.25 5pcs	
BEZ 1071628	Visual fault locator	
BCE 1070135	Alcohol dispenser 150ml without alcohol	
BDC 1070137	Spender box with fibre optic lint-free wipes 10x10 cm 100 pcs.	
BDA 1070130	Fibre optic lint-free wipes to refill spender box 100pcs.	
BCD 1070125	IBC-M250 for in adapter cleaning (2.5mm PC/APC incl. E2000)	
BCD 1070131	IBC-1.25 for in adapter cleaning (1.25mm PC/APC)	
GBC 1019034	Service Adapter E-2000™	
GBC 1019483	Service Adapter F-3000™	
OPTIONS		
GBB 1075023	Adapter E-2000™ PC/APC für simplex, duplex and revos E-2000 connectors	
GBB 1070055	Adapter F-3000™ PC/APC (Only for simplex connector)	
GBB 1074260	Adapter F-3000™ duplex PC/APC	
BCD 1072305	Adapter FSMA	
BEZ 1067799	Adapter \varnothing 2.5 mm / \varnothing 1.25 mm for Visual fault locator	
BCC 1030609	Seikoh Giken Ferrule cleaner "Ferrule Mate", 2,5 mm	
BCC 1038865	Seikoh Giken Ferrule cleaner "Ferrule Mate", 1,25 mm	

Version 0415

INSPECTION EQUIPMENTS

Inspection Microscope		
Order Number	Description	
BCD 1070070	Inspection microscope with universal adapter \varnothing 2.5 mm, \varnothing 1.25 mm and soft case	
OPTIONS		
GBB 1075023	Adapter E-2000™ PC/APC für simplex, duplex and revos E-2000 connectors	
GBB 1070055	Adapter F-3000™ PC/APC (Only for simplex connector)	
GBB 1074260	Adapter F-3000™ duplex PC/APC	
BCD 1072305	Adapter FSMA	

Version 0714